

Super Precision Rolling Bearings

TPI[®]

Super Precision Rolling Bearings



**Pacific International
Bearing, Inc.**

800.228.8895 • www.pibsales.com













CAT NO:2260/TE

TUNG PEI INDUSTRIAL CO., LTD

CAT. NO. 2260/TE

Although care has been taken to assure the accuracy of the data compiled in this catalog, TPI does not assume any liability to any company or person for errors or omissions.

Contents

■ Technical Data	1	
1. High Precision Bearing		
Structure and Arrangement.....	2	
2. Bearing Number Codes	5	
3. Bearing Tolerance and Fits	9	
4. Bearing Load Rating and Life	15	
5. Bearing Preload and Rigidity	18	
6. Bearing Lubrication	26	
7. Bearing Limiting Speed.....	28	
8. Bearing Handling	30	
■ TPI Products	34	
■ Appendices	46	





1. High Precision Bearing Structure and Arrangement

1.1 Bearing Arrangement for Main Spindles

Typical examples of bearing arrangements for main spindles of machine tools are summarized in Table 1.1. An optimal bearing arrangement must be determined through considerations

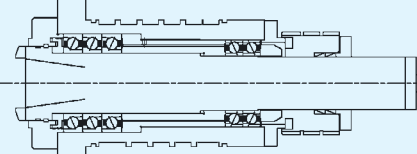
about the properties required of the main spindle in question (maximum speed, radial and axial rigidities, main spindle size, required accuracies, lubrication system, etc.). Recently, an increasing number of new machine tool models incorporate built-in motor type main spindles. However, heat generation on a built-in motor can affect the accuracy of the main spindle and performance of lubricant, so a main spindle bearing should be selected very carefully.

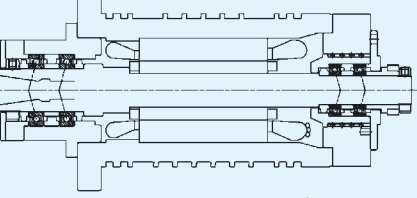
Table 1.1 Typical examples of bearing arrangements for main spindles

Type	Bearing arrangement for main spindle	Bearing type	Lubrication	Typical applications
1	 Belt-driven configuration	Double-row cylindrical roller bearing + High-speed duplex angular contact ball bearing for axial load + Double-row cylindrical roller bearing	Grease	CNC turning machine Machining center Milling machine
2	 Belt-driven configuration	Triple angular contact ball bearing (DBT arrangement) + Duplex angular contact ball bearing (DT arrangement)	Grease	Machining center
3	 Direct-driven configuration	Duplex angular contact ball bearing (DT arrangement) + Duplex angular contact ball bearing (DT arrangement)	Grease	Machining center
4	 Built-in motor-driven configuration	Duplex angular contact ball bearing (DT arrangement) + Duplex angular contact ball bearing (DT arrangement)	Grease/ air Oil	Machining center Small turning machine Grinding machine
5	 Belt-driven configuration	Duplex angular contact ball bearing (DT arrangement) + Duplex angular contact ball bearing (DT arrangement)	Grease/ air Oil/ Oil mist	Grinding machine

1.2 Structure of Spindle Bearings

1.2.1 Duplex Arrangement Bearings

As Fig. 1.1 shows, angular contact ball bearings in duplex arrangements vary in combinations of two, three or four, in accordance to user's required specifications. Back-to-back duplex (DB) arrangement and face-to-face duplex (DF) arrangement can both sustain radial and axial loads in both directions. The wider distance between the effective load centers of the DB arrangement allows larger moment loads to be handled. The main spindle in machine tools often uses this arrangement.

Compared with the DB arrangement, the DF arrangement has shorter distance between the effective load centers, therefore the capacity to handle moment loads is small. However, it possesses greater allowable inclination angle than the DB arrangement.

The tandem duplex (DT) arrangement is able to handle both radial load and large axial load, but only in one direction. The four-row duplex (DTBT) arrangement is commonly used for the main spindles of machining centers because it offers high rigidity and accommodates high-speed operation.

Fig.1.1 Duplex arrangement codes

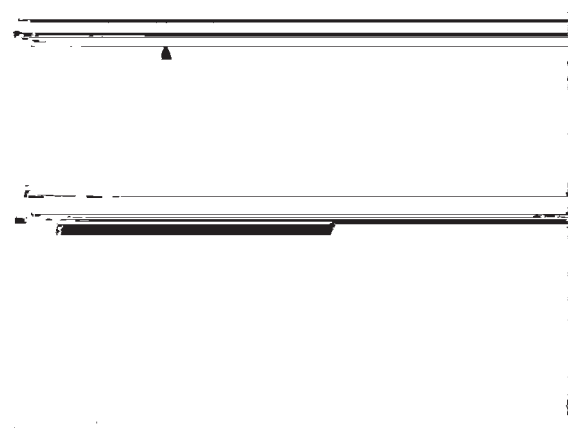

1.2.2 Marking of Bearings and Bearing Sets

A “<-shaped” marking on the outside surface of the outer rings of matched bearing sets indicates how the bearings should be mounted to obtain the proper preload in the set. The marking also indicates how the bearing set should be mounted in relation to the axial load. The “<” should point in the direction in which the axial load will act on the inner ring. In applications where there are axial loads in both directions, the

“<” should point toward the greater of the two loads, refer to Fig. 1.2 °

For universal combination bearings described in 1.2.3, the “<” marking on the outside surface of the outer rings shown in Fig. 1.3, prevent “direction” mistakes, ensure correct matching when they are mounted.

Fig.1.2 A “<-shaped” marking on the outside surface of the outer rings of matched bearing sets

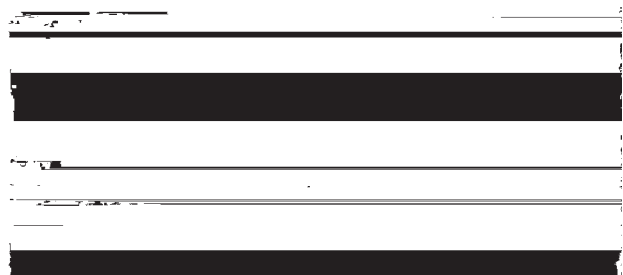
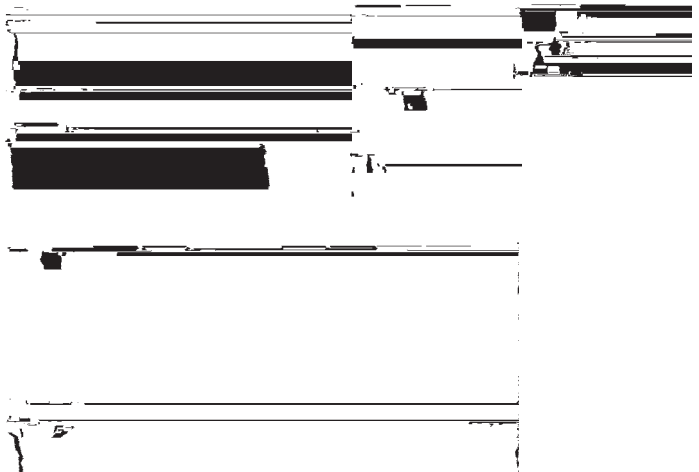
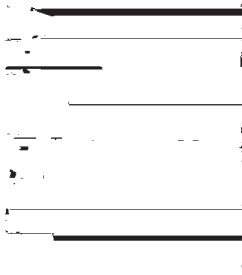

Fig.1.3 A “<-shaped” marking on the outside surface of the outer rings of universal combination bearings



1.2.3 Flush Grinding and Universal Combination

In order to eliminate the face height differences, a finishing technique called "Flush Grinding" is used to make sure that the front and back faces of the inner ring and outer rings are aligned with each other (illustrated in Fig. 1.4). By doing so, specified clearance and preload for DF, DB, and DT sets are ensured, but it is only possible if the combined bearings have the same clearance/preload symbols.

Fig.1.4 Flush grinding

If these combined bearings are used as part of multiple combined bearings, it is recommended that the variation of bore and outer diameter tolerance is within 1/3 of tolerance range. TPI bearings with special accuracy P4X can accommodate small variations of bore and outer diameter tolerance. P4X bearings have the same running accuracy as P4 while has a narrower tolerance range. It is suitable for random matching on universal combination bearings. It also brings convenience for customers to optimize their inventory with more precision P4X bearings.

Universal matching plays an important role in controlling the dimensional differences in the bore and outside diameters between duplex bearings.

When ordering bearings from TPI, please specify the desired number of duplex bearings to be used ("D2" for DB, DF or DT; "D3" for DBT, DFT or DTT). Simply indicate the basic combination and specify universal matching. For specific needs of bore and outside diameter of bearings, please contact TPI for customized tolerance.

1.2.4 Special P4X Accuracy

P4X bearings can control the bearing-to-bearing difference in the bore and outside diameters to no more than one third the tolerance (a minimum of 2 μm) as shown in Table 1.2. Their bearing code normally comes with flushed grinding and universal matching as follows:

Example : 7014C G/GL P4X

Table 1.2 Tolerance of P4 and P4X Accuracy

Tolerance of bore diameter of inner ring unit: μm

Bore diameter (mm)		P4		P4X	
Over	Incl	High	Low	High	Low
30	50	0	-6	-2	-4
50	80	0	-7	-2	-5
80	120	0	-8	-3	-6
120	150	0	-10	-3	-7

Tolerance of outer diameter of outer ring unit: μm

Outer diameter (mm)		P4		P4X	
Over	Incl	High	Low	High	Low
50	80	0	-7	-2	-6
80	120	0	-8	-2	-6
120	150	0	-9	-3	-7
150	180	0	-10	-3	-7

1.2.5 Double-row cylindrical roller bearings

Cylindrical roller bearing is able to support larger radial load than point-contact ball bearing, since the rollers and raceways are in linear contact. Its structure is also suitable for high-speed operation.

TPI's double-row cylindrical roller bearings are available in two types: NN and NNU, and two series: 30 and 49. The rollers in the NN type are guided by the ribs of inner ring; whereas the rollers in the NNU type are guided by the ribs of the outer ring. Tapered bore type (allows adjustment of radial internal clearance of bearing) or a standard cylindrical bore are available for selection. In addition, TPI offers the standard type and high-speed type to satisfy our customer's demands. For standard type, a set of machined brass cages are used while high temperature special molded resin cages for high-speed applications. They can be used for both grease lubrication and air-oil lubrication.

1.2.6 Angular Contact Thrust Ball Bearings

A range of thrust bearings used in machine tools for the main spindles. They includes 5629 and 5620 series for high axial rigidity (contact angle 60°) and HTA series high-speed duplex angular contact ball bearings for axial loads with optimized internal design (contact angle 40° , 30°). These bearings are used in conjunction with NN30, NN49, or NNU49 series double-row cylindrical roller bearings (matched bearings must have the same bore and outside diameter).

These duplex angular contact ball bearing series have similar design to the double-row thrust angular contact ball bearing series, but are different in terms of their width. Since their contact angles are lower at 40° and 30°, the series boast high speed capability. However, their axial rigidity is less than double-row thrust angular contact ball bearings with 60° contact angle.

1.3 Ball Screw Support Bearings

Ball Screw Support (BS) Bearings have the maximum possible number of small balls and thicker inner & outer rings, with the contact angle at 60°. This design allows greater axial rigidity. Since balls are used instead of rollers as rolling elements, starting torque is thus less than roller bearings.

Flushing grinding technique is used to ensure that the face height differences of BS type bearings are the same on both sides. This advantage allows the users to freely combine bearings with the same part numbers into DB, DBT, DTBT arrangements, and there is no need to adjust relevant preload anymore. It is also available for special request on bearing material, grease, sealing and so on. Please contact TPI for further information.

The BS type is mainly installed on ball screws of machine tool feed systems, and two to four rows arrangements are used in many cases. Both back-to-back and face-to-face duplex arrangement are used in this application. The face-to-face duplex arrangement may be used if misalignment is un-avoidable as shown in Fig.1.5.

Fig.1.5 Two to four row arrangements are used on ball screws of machine tool feed systems

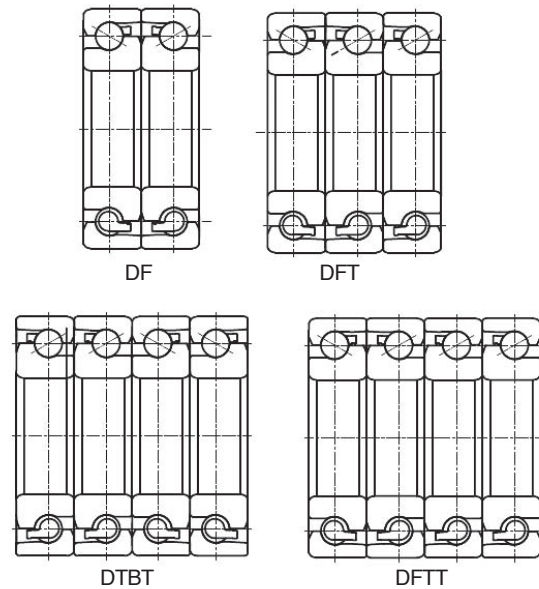

2 Bearing Number Codes

2.1 Bearing Designations

Rolling bearing part numbers indicate bearing type, dimensions, tolerances, internal construction, and other related specifications. Bearing numbers

are comprised of a "basic number" followed by "supplementary codes." The makeup and order of bearing numbers is shown in Table 2.1, 2.2.

Table 2.1 Number and code arrangement for angular contact ball bearings

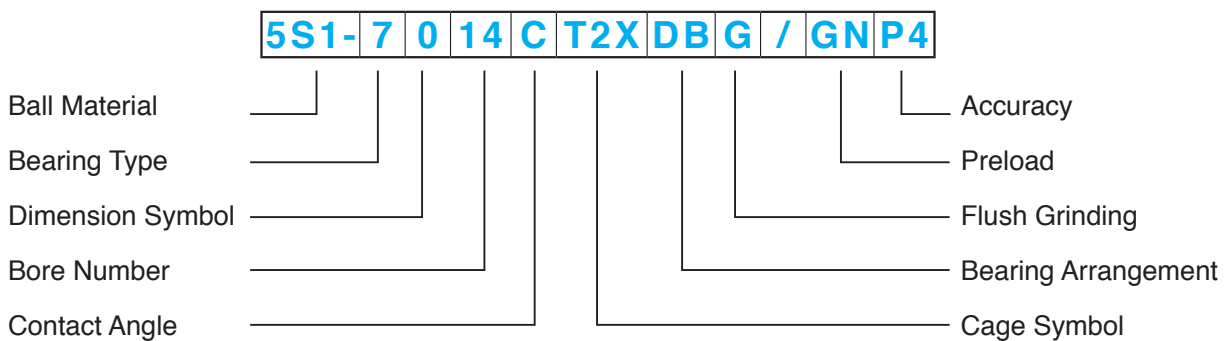

Ball material	5S1-	Si ₃ N ₄ (Ceramic ball)
	Blank	SUJ2 (Steel ball)
Bearing type	7	Single-row angular contact ball bearing
	HS	High speed angular contact ball bearing
	BT	High speed Thrust angular contact thrust ball bearing
	BS	Ball screw support bearing
Diameter symbol	9	BS may not show in code
	0	
	2	
Bore number	8	BS Shown (I.D.)(O.D.)
	.	
	20	
Contact angle	C	15°
	CE1	18°
	AD	25°
	A	30°
	B	40°
Cage symbol	T1	Phenolic machined cage
	T2	Engineering plastic molded cage
Bearing arrangement	DB	Back to back arrangement
	DF	Face to face arrangement
	DT	Tandem arrangement
	DBT	Tandem and back to back (triple-row)
	DTBT	Tandem and back to back (quad-row)
Flush grinding	G	Flush ground type
	Blank	Without flush ground
Preload	GL	Light preload
	GN	Normal preload
	GM	Medium preload
	GH	Heavy preload
	GXX	Special preload
Accuracy	P5	JIS standard class 5
	P4	JIS standard class 4
	P4X	JIS standard class 4 ∖ Special bore and outside diameter tolerance
	P4L	JIS standard class 4 ∖ Special outer diameter tolerance
	P42	JIS standard class 4(dimensional) ∖ JIS standard class 2(running accuracy)
	P4A	JIS standard class 4 ∖ Special bore and outside diameter tolerance
	P2	JIS standard class 2

Table 2.2 Number and code arrangement for double-row cylindrical roller bearings

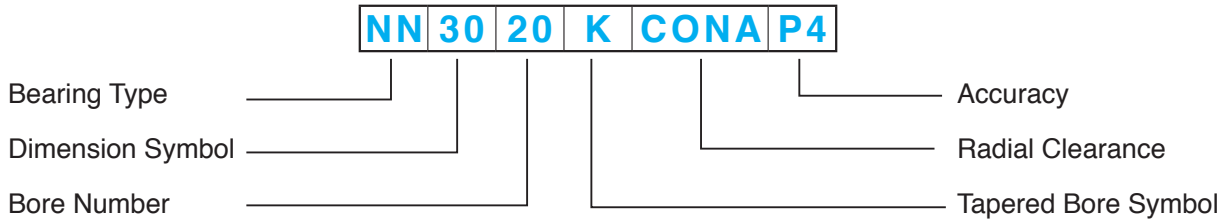

Bearing type	NN	Double row with ribbed inner ring
	NNU	Double row with ribbed outer ring
Dimension symbol	30	
	49	
Bore number	11	
	.	
	34	
Cage symbol	T2	Engineering plastic molded cage
	Blank	Machined brass
Tapered bore symbol	K	Tapered inner ring bore ,taper ratio1/12
	Blank	Cylindrical inner ring bore
Radial clearance	C0NA	Internal clearance smaller than Normal
	C1NA	Internal clearance smaller than Normal
	C2NA	Internal clearance smaller than Normal
	NA	Normal internal clearance
Accuracy	P5	JIS standard class 5
	P4	JIS standard class 4
	P2	JIS standard class 2

2.2 Bearing Marking

Each TPI high precision bearing is marked with various identifiers on one side face of the inner and outer ring as shown in Fig. 2.1. Outer diameter and width deviation from the nominal diameter are marked on the outer ring, bore diameter and offset of flush side face on the inner ring. “\” marks the position of the maximum eccentricity.

2.3 Comparison Table of TPI bearings with Other Brand Bearings

For user’s convenience, Table 2.3 lists TPI bearing number codes with those of other brand bearings side by side as quick reference to identify bearing characteristics including bearing series, dimensions, tolerance, and other internal structure etc.

Fig.2.1 Bearing marking designation

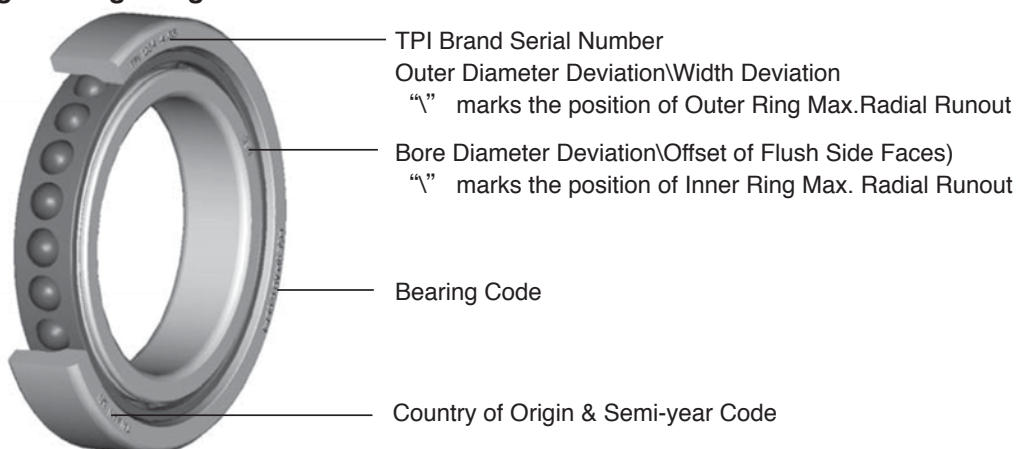

Table 2.3 Comparison Table of TPI bearings with other brand bearings

		Code						Explanation
Brand	TPI	NTN	NSK	FAG	SKF	GMN		
Basic numbers	Ball material	5S1-	5S-	H	HC-	C-or/HC	HY	Si ₃ N ₄ Ceramic balls
		Blank	Blank	Blank	Blank	Blank	Blank	SUJ2
	Bearing type	7	7	7	B7	7	S	Standard type ACBB
		HS	HSE	BNR,BER	HS-,HC-	CE,DB,FB	KH	High Speed Type ACBB
		BS	BST B	TAC B	BSB	BSD	—	Ball Screw Support Bearing (60° angle)
		BT A BT B	HTA A HTA B	BAR BTR	—	BTM A BTM B	—	High Speed Thrust ACBB
		9	9	9	19	19	19	BS may not shown in code
	0	0	0	0	0	0		
	2	2	2	2	2	2		
	Bore diameter number	8	6	5	6	8	5	BS shown I.D.x O.D.
		:	:	:	:	:	:	
		20	26	40	48	48	24	
	Contact angle	C	C	C	C	CD,CE	C	15°
		CE1	—	(BNR)	—	FB	18°	18°
		AD	AD	A5,(BER)	E	ACD,ACE,DB	E	25°
Cage symbol	T1	T1	TR	T	Blank	TA	Phenolic machined cage	
	T2	T2	TYN	—	TN,TN9	—	Engineering plastic molded cage	
Basic numbers	Seal	LLB	LLB	V1V	HSS-	—	2RZ	Non-contact rubber seal
		LLE	—	DDG	—	—	—	Light contact rubber seal
	Matching code	DB	DB	DB	DB	DB	DB	Back to back (double-row)
		DF	DF	DF	DF	DF	DF	Face to face (double-row)
		DT	DT	DT	DT	DT	DT	Tandem (double-row)
		DBT	DBT	DBD	TBT	TBT	TBT	Tandem and back to back (triple-row)
		DTBT	DTBT	DBT	QBC	QBC	QBC	Tandem and back to back (quad-row)
	Flush grinding	G	G	SU	U	G		Flush ground type
	Preload	GL	GL	EL	—	A	UL	Light preload
		GN	GN	L	L	B	UM	Normal preload
		GM	GM	M	M	C	US	Medium preload
		GH	GH	H	H	—	—	Heavy preload
		Gxx	Gxx	CP	—	Gxxx	UV	Special preload
	Accuracy	P4	P4	P4	—	P4A,P7	P4	JIS standard Class 4
		P4X	—	P4Y	—	Blank	—	JIS standard Class 4、 Special bore and outside diameter tolerance
P42		P42	P3	P4S	P4A	A7/9	Dimensional precision JIS standard Class 4; running accuracy JIS standard Class 2	
P2		P2	P2	—	PA9A,P9	P2	JIS standard Class 2	

3 Bearing Tolerance and Fits

3.1 Bearing Tolerance

Bearing “tolerances” or dimensional accuracy and running accuracy are regulated by ISO 492:2002 and JIS B 1514 standards (rolling bearing tolerances) shown in Table 3.1.

When mounting a bearing to a shaft or housing, the dimensional accuracy is crucial in satisfying the tolerance. A permissible run-out occurring when rotating a bearing by one revolution is defined by the running accuracy. Appendix III shows bearing accuracy for angular contact ball bearings, BS series bearings, and cylindrical roller bearings. Methods for measuring the accuracy of rolling bearings are described in JIS B 1515 and in Table 3.2.

Table 3.1 Bearing types and applicable tolerance and comparison of tolerance classifications of national standards

Table 3.1 Bearing type and tolerance classes						
Bearing type		Applicable Tolerance Class				
Deep Groove Ball Bearings		Normal	Class 6	Class 5	Class 4	Class 2
Angular Contact Ball Bearings		Normal	Class 6	Class 5	Class 4	Class 2
Cylindrical Roller Bearings		Normal	Class 6	Class 5	Class 4	Class 2
Needle Roller Bearings		Normal	Class 6	Class 5	Class 4	—
Tapered Roller Bearings	Metric Design	Class 0,6X	—	Class 5	Class 4	—
	Inch Design	ANSI/ABMA CLASS 4	ANSI/ABMA CLASS 2	ANSI/ABMA CLASS 3	ANSI/ABMA CLASS 0	ANSI/ABMA CLASS 00
Thrust Ball Bearing		Normal	Class 6	Class 5	Class 4	—
Double row angular contact thrust ball bearing		TPI standard	—	Class 5	Class 4	—



Equivalent standards (Reference)		Applicable Tolerance Class				
JIS ⁽¹⁾		Class 0	Class 6	Class 5	Class 4	Class 2
DIN ⁽²⁾		P0	P6	P5	P4	P2
ANSI/ABMA ⁽³⁾	Ball Bearing	ABEC1	ABEC3	ABEC5	ABEC7	ABEC9
	Roller Bearing	RBEC1	RBEC3	RBEC5	—	—
	Tapered Roller Bearing	CLASS 4	CLASS 2	CLASS 3	CLASS 0	CLASS 00

NOTE: (1) JIS: Japanese Industrial Standards (JIS B 1514)

(2) Deutsch Industries Norm (DIN 620)

(3) ANSI/ABMA: The American Bearing Manufacturers Association

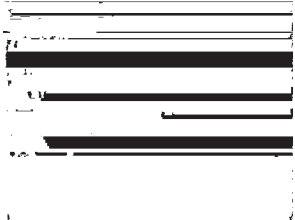
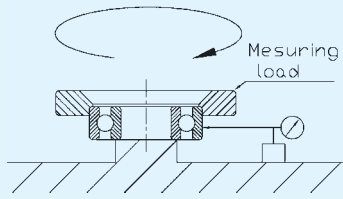
Table 3.2 Measuring methods for running accuracies

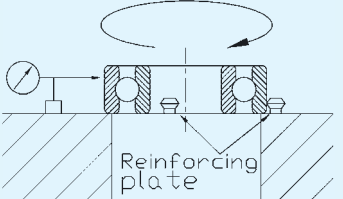
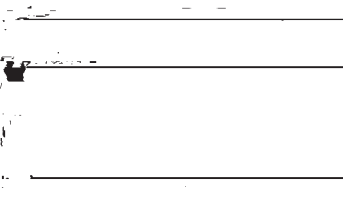
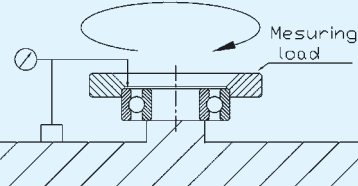
Running accuracy	Measurement principle
K_{ia} = Inner ring radial runout	
K_{ea} = Outer ring radial runout	
S_d = Inner ring side runout with bore	
S_D = Outer ring outside surface inclination	
S_{ia} = Inner ring axial runout	
S_{ea} = Outer ring axial runout	

A super-precision bearing that conforms to the user's main spindle specifications must be chosen in order to attain a higher level of running accuracy required of a main spindle of machine tool. A super-precision bearing of JIS accuracy class 5, 4, or 2 is usually selected according to its application. The main spindle's running accuracy needs to be strictly controlled because it is affected by the radial run-out, axial run-out and non-repetitive run-out of the main spindle bearing. The super precision machine tools requires finely controlled N.R.R.O. (Non-Repetitive Run-out), therefore the main spindle on a turning machine or machining center often utilizes N.R.R.O. accuracy controlled bearings.

TPI's cylindrical roller bearings comply with JIS Classes 4 and 2 specifications, as shown in Table 3.3. Poor accuracies of the tapered bore may lead to misalignment of the inner ring, causing poor performance of the bearing; in severe cases, premature seizure and flaking may occur. Using a taper gauge is recommended for achieving higher accuracy on the main spindle. Please refer to "8. Bearing Handling: 8.6 Clearance adjustment for cylindrical roller bearing" for more information on taper angle.

Table 3.3 Tolerance of taper-bored bearings

d (mm)		Δd_{mp}		Reference $\Delta d_{1mp} - \Delta d_{mp}$		V_{dp}
over	incl.	high	low	high	low	max
18	30	+13	0	+3	0	4
30	50	+16	0	+3	0	5
50	80	+19	0	+4	0	6
80	120	+22	0	+5	0	7
120	180	+25	0	+7	0	9
180	250	+29	0	+9	0	12

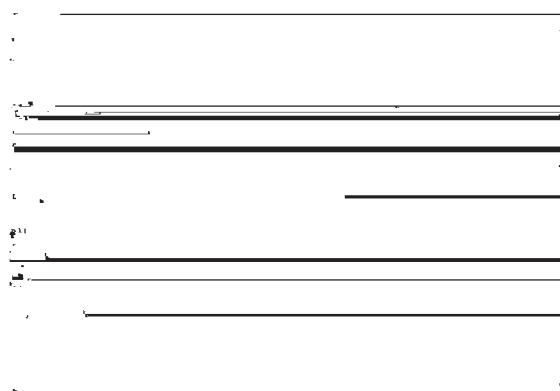

Δd_{mp} : Single plane mean bore diameter deviation in the theoretical small bore end of the bore

Δd_{1mp} : Single plane mean bore diameter deviation in the theoretical large bore end of the bore

3.2 N.R.R.O. (Non-Repetitive Run-Out) of bearing

Accuracies of rolling bearings are defined by ISO and JIS standards. Table 3.2 shows the methods for measuring running accuracies. A rotating bearing in a machine tool operates in a continuous revolving motion that involves more than once revolution. As shown in Fig.3.1, the actual run-out accuracy with a rotating bearing includes elements that are not synchronous with the revolution of a bearing, as a result, the trajectory of plotting with running accuracies vary with each revolution.

The run-out of an element not in synchronization with the revolutions of bearing may be caused by form accuracy of raceways, dimension tolerance of rolling elements, and N.R.R.O. accuracy of cage under high-speed condition etc. Improvement in spindle form accuracy could lead to higher precision work piece and better tolerance and surface roughness of mold tooling.

Fig.3.1 Illustration of non-repetitive run-out

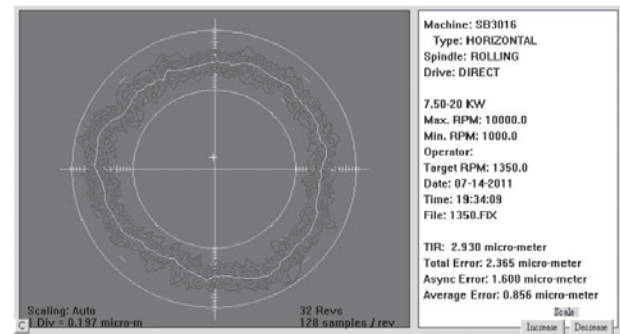

3.3 Accuracies of Shaft and Housing

The bearing's internal clearance may vary, depending on the fit of a bearing to a shaft and a housing. It is important to make sure that an adequate bearing fit is attained to achieve desired bearing performance. Table 3.4 and 3.5 show the accuracies of shaft and housing.

The axial tightening torque on a bearing should be carefully considered, because too much axial tightening may cause deformation of the bearing raceway surface. Please take time to carefully determine the dimensions of components associated with a tightening force, the magnitude of tightening force, and the number of tightening bolts.

When designing a bearing and housing, in order to maintain bearing and housing accuracies and also to avoid interference with the bearing related corner radius, it is important to provide a sufficient shoulder height for the bearing and housing. Table 3.6 shows the chamfer dimensions and the recommended shoulder height. Table 3.7 lists the corner radius on the shaft and housing. Relief dimensions for ground shaft and housing fitting surfaces are given in Table 3.8.

Table 3.4 Form accuracy of spindle

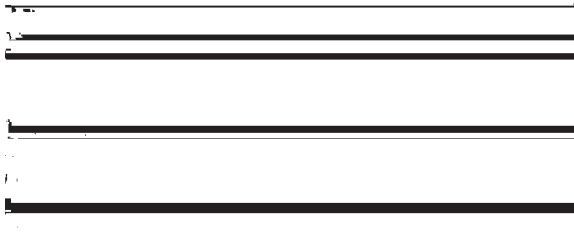

Shaft Diameter (mm)		Roundness(○)			Cylindricity(∅)			Runout(↗)			Concentricity(◎)			Roundness		
		a			b			c			d			R _a		
		Bearing Accuracy			Bearing Accuracy			Bearing Accuracy			Bearing Accuracy			Bearing Accuracy		
over	incl	P5	P4	P2	P5	P4	P2	P5	P4	P2	P5	P4	P2	P5	P4	P2
-	10	1.3	0.8	0.5	1.3	0.8	0.5	2	2	1.3	4	4	2.5	0.2	0.2	0.1
10	18	1.5	1	0.6	1.5	1	0.6	2.5	2.5	1.5	5	5	3	0.2	0.2	0.1
18	30	2	1.3	0.8	2	1.3	0.8	3	3	2	6	6	4	0.2	0.2	0.1
30	50	2	1.3	0.8	2	1.3	0.8	3.5	3.5	2	7	7	4	0.2	0.2	0.1
50	80	2.5	1.5	1	2.5	1.5	1	4	4	2.5	8	8	5	0.2	0.2	0.1
80	120	3	2	1.3	3	2	1.3	5	5	3	10	10	6	0.4	0.4	0.2
120	180	4	2.5	1.8	4	2.5	1.8	6	6	4	12	12	8	0.4	0.4	0.2
180	250	5	3.5	2.3	5	3.5	2.3	7	7	5	14	14	10	0.4	0.4	0.2

Table 3.5 Form accuracy of housing

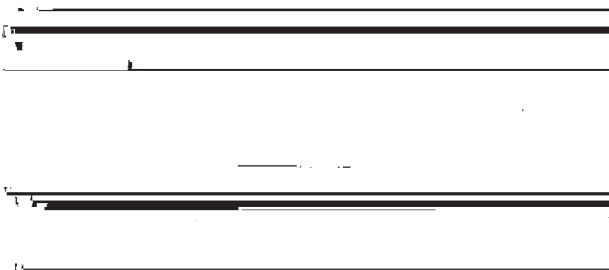

Housing bore diameter (mm)		Roundness(○)			Cylindricity(∅)			Runout(↗)			Concentricity(◎)			Roundness		
		a			b			c			d			R _a		
		Bearing Accuracy			Bearing Accuracy			Bearing Accuracy			Bearing Accuracy			Bearing Accuracy		
over	incl	P5	P4	P2	P5	P4	P2	P5	P4	P2	P5	P4	P2	P5	P4	P2
-	10	1.3	0.8	0.5	1.3	0.8	0.5	2	2	1.3	4	4	2.5	0.4	0.4	0.2
10	18	1.5	1	0.6	1.5	1	0.6	2.5	2.5	1.5	5	5	3	0.4	0.4	0.2
18	30	2	1.3	0.8	2	1.3	0.8	3	3	2	6	6	4	0.4	0.4	0.2
30	50	2	1.3	0.8	2	1.3	0.8	3.5	3.5	2	7	7	4	0.4	0.4	0.2
50	80	2.5	1.5	1	2.5	1.5	1	4	4	2.5	8	8	5	0.8	0.8	0.4
80	120	3	2	1.3	3	2	1.3	5	5	3	10	10	6	0.8	0.8	0.4
120	180	4	2.5	1.8	4	2.5	1.8	6	6	4	12	12	8	0.8	0.8	0.4
180	250	5	3.5	2.3	5	3.5	2.3	7	7	5	14	14	10	1.6	1.6	0.8

Table 3.6 Allowable critical-value of bearing chamfer Radial bearings

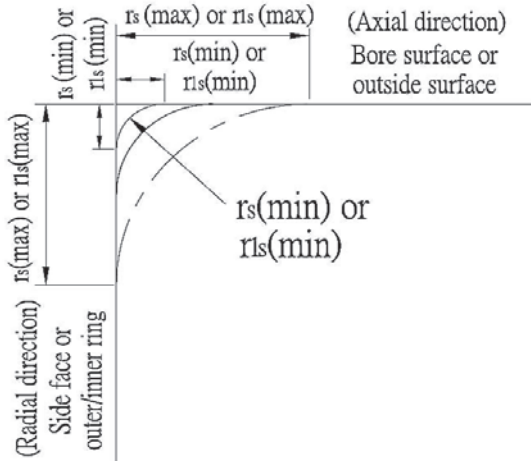

① These are the allowable minimum dimensions of the chamfer dimension "r" or "r1" and are described in the dimensional table.

Unit : mm

Permissible Chamfer Dimension: r_s (min) or r_{1s} (min)	Nominal Bore Diameter		Permissible Chamfer Dimension: r_s (max) or r_{1s} (max)	
	d		Radial Direction	Axial Direction
	over	incl		
0.05	—	—	0.1	0.2
0.08	—	—	0.16	0.3
0.1	—	—	0.2	0.4
0.15	—	—	0.3	0.6
0.2	—	—	0.5	0.8
0.3	—	40	0.6	1
0.3	40	—	0.8	1
0.6	—	40	1	2
	40	—	1.3	2
1	—	50	1.5	3
	50	—	1.9	3
1.1	—	120	2	3.5
	120	—	2.5	4
1.5	—	120	2.3	4
	120	—	3	5
2	—	80	3	4.5
	80	220	3.5	5
	220	—	3.8	6

Table 3.7 Fillet radius and abutment height

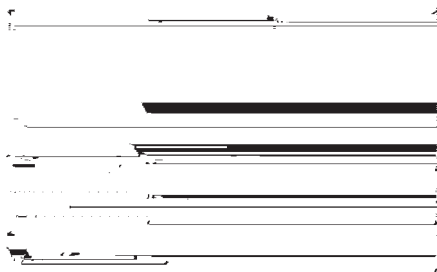

Unit : mm

Nominal Chamfer Dimensions	Filter Radius	Minimum Shoulder Heights
r_s (min) or r_{1s} (min)	r_{as} (max)	h (min)
0.05	0.05	0.3
0.08	0.08	0.3
0.1	0.1	0.4
0.15	0.15	0.6
0.2	0.2	0.8
0.3	0.3	1.25
0.6	0.6	2.25
1	1	2.75
1.1	1	3.5
1.5	1.5	4.25
2	2	5
2.1	2	6
2.5	2	6
3	2.5	7
4	3	9
5	4	11
6	5	14
7.5	6	18
9.5	8	22
12	10	27
15	12	32
19	15	42

If bearing supports large axial load, the height of the shoulder must exceed the value given here.

Note: r_{as} (max) maximum allowable filler radius.

Table 3.8 Relief dimensions for grinding

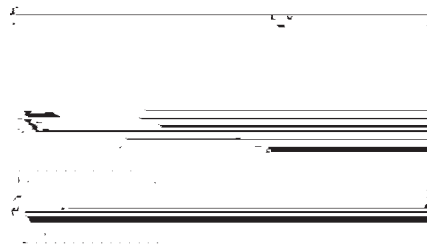

Unit : mm

Chamfer Dimensions of Inner and Outer	Relief Dimensions		
	r_s (min) or r_{1s} (min)	b	r_e
1	2	1.3	0.2
1.1	2.4	1.5	0.3
1.5	3.2	2	0.4
2	4	2.5	0.5
2.1	4	2.5	0.5
2.5	4	2.5	0.5
3	4.7	3	0.5
4	5.9	4	0.5
5	7.4	5	0.6
6	8.6	6	0.6
7.5	10	7	0.6

3.4 Shaft and Housing fits

The performance of bearings such as speed capability and running accuracy is influenced by the seats and the precision of the selected fits of shaft and housing. Recommended fits for general operating conditions at inner ring rotation of precision bearings used for machine tools are shown in Tables 3.9, 3.10 and 3.11. If the dmN value (dmN : pitch circle diameter across rolling elements [mm] multiplied by speed [min.^{-1}]) is higher than the value of one million, one should consider the expansion of inner ring caused by centrifugal force. It also influences preload in bearings. In this case, more detailed analysis is needed from some simulation tools such as TH-BBAN software for determining bearing fit and possibly increasing interference fit to compensate the centrifugal effect.

For high speed thrust angular contact ball bearing, or so-called biaxial thrust BT angular contact ball bearing, fits also given in Tables 3.9, 3.10 are recommended. Since a paired of angular contact ball bearing is normally used with a cylindrical roller bearing, the requirement of accuracies of shaft and housing needs to be considered the same as a cylindrical roller bearing is used. For a cylindrical roller bearing with taper bore, when mounting a tapered bore bearing onto a shaft, it should make good contact with its seat to maintain high precision of the bearing.

For ball screw support bearings (BS series type) recommended fit of shaft and housing are $h5$ and $H6$ respectively. The tolerances of shoulder squareness is within $4 \mu\text{m}$ for diameter less than 80 mm.

Table 3.9 Shaft fit for high precision bearings

Bearing type	Shaft diameter (mm)		Bearing accuracy class			
			Class 5		Class 4 /Class 2	
	over	incl.	Desired fit	Shaft tolerance	Desired fit	Shaft tolerance
Angular contact ball bearing	10	18	0~2T	h4	0~2T	h3
	18	50	0~2.5T	h4	0~2.5T	h3
	50	80	0~3T	h4	0~3T	h3
	80	150	0~4T	js4	0~4T	js3
	150	200	0~5T	js4	0~5T	js3
Cylindrical roller bearing (cylindrical bore)	25	40	—	js4	—	js4
	40	140	—	k4	—	k3
	140	200	—	k4	—	k3
high speed thrust angular contact ball bearing	For all shaft diameters		0~6L	h4	0~6L	h4
Ball screw support bearings	For all shaft diameters		0~10L	h5	0~10L	h5

Table 3.10 Housing fit (fixed side) for high precision bearings

Bearing type	Housing bore diameter (mm)		Bearing accuracy class			
			Class 5		Class 4 /Class 2	
	over	incl.	Desired fit	Housing bore tolerance	Desired fit	Housing bore tolerance
Angular contact ball bearing	18	50	0~3L	JS4	0~3L	JS3
	50	120	0~4L	JS4	0~4L	JS3
	120	180	0~5L	JS4	0~5L	JS3
	180	250	0~6L	JS4	0~6L	JS3
Cylindrical roller bearing (cylindrical bore)	Overall housing bore		± 0	K5	± 0	K5
high speed thrust angular contact ball bearing	Overall housing bore		30L~40L	K5	30L~40L	K5
Ball screw support bearings	Overall housing bore		10L~20L	H6	10L~20L	H6

Table 3.11 Housing fit (free side) for high precision bearings

Bearing type	Housing bore diameter (mm)		Bearing accuracy class			
			Class 5		Class 4 /Class 2	
	over	incl.	Desired fit	Housing bore tolerance	Desired fit	Housing bore tolerance
Angular contact ball bearing	18	50	6L~10L	H4	6L~10L	H3
	50	120	8L~13L	H4	8L~13L	H3
	120	180	12L~18L	H4	12L~18L	H3
	180	250	15L~22L	H4	15L~22L	H3
Cylindrical roller bearing (cylindrical bore)	Overall housing bore		±0	K5	±0	K4
Ball screw support bearings	Overall housing bore		10L~20L	H6	10L~20L	H6

4 Bearing Load Rating and Life

Even under normal conditions, the surfaces of the raceway and rolling elements of a bearing are subjected to repeated compressive stresses, which will eventually cause flaking of these surfaces to occur. Flaking is a sign of material fatigue, which may eventually lead to bearing failure. A bearing's effective life is usually defined by the total number of revolutions the bearing can undergo before flaking on either the raceway surface or rolling element surfaces occur.

Others causes of bearing failure may include seizing, abrasions, cracking, chipping, gnawing, rust, etc. These "causes" are often related to improper installation, insufficient or improper lubrication, faulty sealing or inaccurate bearing matching or selection. In another word, man-caused bearing failure can be avoided by taking precautions, and they should be separately considered from the flaking aspect that is related to material fatigue.

In most cases, the load exerted on the main spindle of a machine tool is relatively small compared to the dynamic load on the bearing. Therefore, the fatigue life of a bearing seldom poses a problem. Rather, bearing size is almost determined by other factors such as system rigidity or fixed dimensions of the spindle as well as the speed and feed parameters of the application.

4.1 Basic Rating Life and Basic Dynamic Load Rating

The general information about bearing life calculation and basic load ratings is also valid for high precision bearings. It should be noted that all life calculations are based on ISO 281:2007.

The basic rating life for a radial ball bearing is given by the life equation:

$$L_{10} = \left(\frac{C_r}{P} \right)^p$$

where ,

L_{10} : basic rating life at 90% reliability, millions of revolutions

p : exponent of the life equation

: 3 for ball bearings

: 10/3 for roller bearings

C_r : Basic dynamic load rating, N or kgf

P : The equivalent dynamic load N or kgf

The basic dynamic load rating C_r is also defined in ISO 281:2007. It expresses the bearing load that will provide a basic life on one million revolutions. It is assumed that the load is constant in magnitude and direction and is radial for radial bearings or axial for thrust bearings.

To calculate bearing life with basic dynamic load ratings, it is necessary to convert the actual dynamic loads into an equivalent dynamic bearings load. The equivalent dynamic bearing load P is defined as a hypothetical load, constant in magnitude and direction, acting radially for radial bearing or axially for thrust bearings. It is used to represent the effect that the actual load would have on bearing life.

The basic dynamic load rating and equivalent dynamic bearings load are listed in precision being tables for TPI standard bearing materials, using standard manufacturing techniques. Please consult TPI for basic load ratings of bearings constructed of special materials or using special manufacturing techniques.

When calculating the basic dynamic radial load rating for two similar single-row angular contact ball bearings mounted side by side on the same shaft, such that they operate as a unit (DB or DF arrangement), the pair is considered as one

double-row angular contact ball bearing. For two or more similar such bearings mounted side by side in a tandem arrangement, the basic dynamic radial load rating is the number of bearings to the power of 0.7 times the rating of one single-row bearing.

4.2 New Bearing Life Formula

As Fig 4.1 shows, based on the earlier work of Weibull, Lundberg-Palmgren (L-P) established a theory and method to predict the fatigue life of rolling bearings. The basic equation of the L-P theory is:

$$\ln \frac{1}{S} \propto \frac{N^e \tau_0^c}{z_0^h} V$$

where ,

N : the number of stress cycles endured with probability of survival S ,

τ_0 : the maximum value of subsurface orthogonal shear stress as the failure-causing stress,

V : the volume of subsurface material subjected to stress, and

Z_0 : the depth at which τ_0 occurs.

For many applications, prediction of bearing fatigue life using the Lundberg-Palmgren theory life modified by serial multiplication of life adjustment factors is substantially inaccurate. This is especially true for bearings in applications involving relatively light loads; e.g., applications in which the maximum Hertz stress is less than 1400 MPa (approximately 200 kpsi).

The Ioannides-Harris (I-H) theory, an extension of the Lundberg-Palmgren theory, introduced the concept of a fatigue limit stress. Under the same Weibull weakest link theory, the probability of survival ΔS_i of a volume ΔV_i , sufficiently large to contain many defects, can be generally expressed as:

$$\ln \frac{1}{\Delta S_i} \propto \frac{N^e (\sigma_{VM,i} - \sigma_{VM,lim})^c \Delta V_i}{z_i^h}$$

A major feature of the Ioannides-Harris theory is that it compares the total stress at any point in the rolling component to the fatigue limit. The total stress at each point is calculated using the Von Mises stress. The life of each ball-raceway contact is determined by numerical integration of the field of Von Mises stresses. Bearing fatigue life is determined by statistical combination of the rolling component lives. If this value is equal to or less than 0, then the elemental volume will not experience fatigue. Fig. 4.2 illustrates schematically the load-life relationship between L-P and I-H theories. Fig. 4.3 shows the stress volume resulting from rolling contact according to I-H theory.

Fig. 4.1 Stress volume resulting from rolling contact according to L-P theory

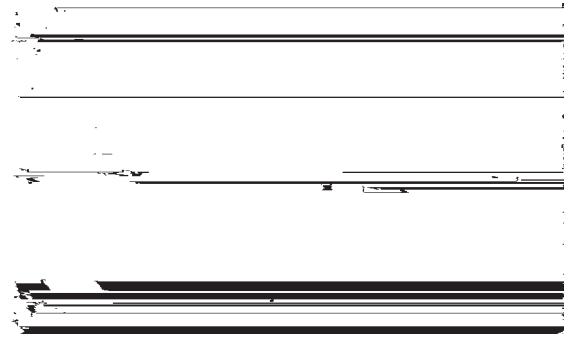

Fig. 4.2 Load-life comparison between L-P and I-H theories

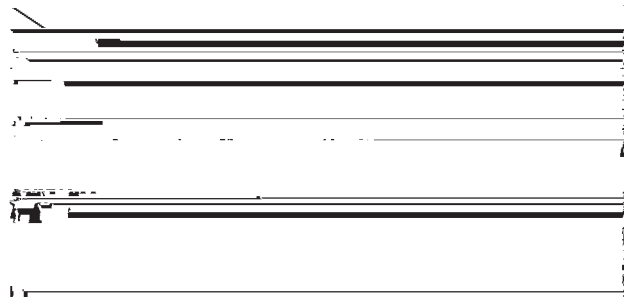

Fig. 4.3 Stress volume resulting from rolling contact according to I-H theory



Lundberg-Palmgren states that the volume under stress is proportional to the volume of the cylindrical ring. This proportionality is only valid when simple Hertz contact is applied to a smooth surface. The L-P theory also does not account for the effect of temperature on lubrication and hence on shear stresses. A number of shortcomings of the L-P theory became apparent in the decades.

The stress-life method based on I-H theory for prediction of bearing fatigue life considers the integrated effect of all stresses acting on the rolling component surfaces together with those stresses within the component. The latter stresses may be caused by ring rotation, mounting of the inner ring on the shaft or the outer ring in the housing, heat treatment of the component, or surface forming and finishing processes. In addition to

the Hertz stresses, which tend to be the stresses of greatest influence on bearing fatigue life, stresses are caused by shearing of the lubricant in the contacts and friction between asperities on mating surfaces when lubricant film thickness is insufficient to completely separate the surfaces. Moreover, dents in the rolling surfaces caused by hard particle contamination result in stress concentrations, which augment both the Hertz and surface shear stresses. This was accomplished using the analytical TH-BBAN computer program developed by the concept of a stress-life to fulfill the requirement for the interdependency of the various fatigue life-influencing factors. TH-BBAN calculates fatigue life of each ball-raceway contact is accomplished by evaluation of a life integral according to the total or actual stress condition compared to the life integral corresponding to the simple Hertz stress application shown as follows:

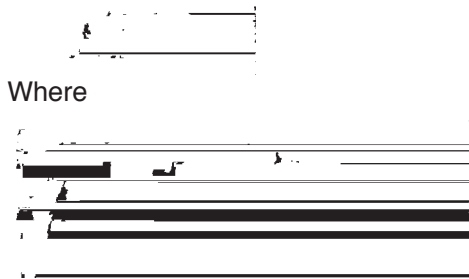

Where

A_{SL} is called the contact stress-life factor in TH-BBAN. As an alternative to the life formula, ISO 281:2007 established the bearing life equation format as follows:

$$L_n M = A_1 A_{ISO} L_{10}$$

$L_n M$: the basic rating life modified for a reliability (100-n)%

A_1 : the reliability-life factor

A_{ISO} : the integrated life factor, including material, lubrication and contamination effects (ISO 4406 cleanliness code adopted)

4.3 Static Load Rating and Allowable Axial Load

In practice, permanent deformations of small magnitude occur even under light loads. If the deformations become much larger, the cavities formed in the raceways cause the bearing to vibrate and become noisier. Moreover, indentations together with conditions of marginal lubrication can lead to surface-initiated fatigue.

Experience has shown that permanent deformations have little effect on the operation of the bearing if the magnitude at any given contact point is limited to a maximum of 0.0001 times the diameter of the rolling element.

The basic static load rating of a rolling bearing is defined as that load applied to a non-rotating bearing that will result in permanent deformation of 0.0001 times the diameter of the rolling element at the weaker of the inner or outer raceway contacts occurring at the position of the maximum loaded rolling element. For ball bearings, the maximum applied load value for contact stress occurring at the rolling element and raceway contact points are 4200MPa or 428kgf/mm².

A sufficient safety factor to protect the bearing from permanent deformation can be obtained when

$$P_o \leq \frac{C_o}{S_o}$$

where,

P_o : equivalent static bearing load, N or kgf

C_o : basic static load rating, N or kgf

S_o : static safety factor

The basic static load rating C_o is defined in ISO 76:2006. It corresponds to a calculated contact stress at the center of the most heavily loaded rolling element/raceway contact that produces a permanent deformation of the rolling element diameter. The loads are purely radial for radial bearings and axial for thrust bearings. The basic static load rating C_o is listed in the bearing tables.

To compare actual loads with the basic static load rating, the actual loads must be converted into an equivalent load. This is defined as that hypothetical load which, if applied would cause the same maximum rolling element load in the bearing as the loads to which the bearing is subjected.

4.4 Bearing Life for High Speed Application

For high-speed applications, the effects of ball centrifugal forces and gyroscopic moments need to be included. The force and moment equilibrium equations for the bearing inner ring are solved for the bearing axial, radial, and angular deflections. If the bearing has a complement of Z balls, then a system of 4Z+5 equations is solved numerically using the Newton-Raphson method.

For the analysis including the determination of ball friction forces and speeds, in addition to the 5 force and moment load equilibrium equations for the inner ring, the torques acting on the cage in the plane of bearing rotation are balanced, and cage speed is determined. In this case a system of 9Z+6 equations are solved numerically. TPI's HS high-speed type angular contact ball bearings are optimally designed with their internal configuration to accommodate both low frictional heat or ball skidding effect and high rigidity by using TH-BBAN.

4.5 Life for Hybrid Bearings

When calculating the rating life for hybrid bearings, the same life values can be used as for all-steel bearings. The ceramic balls in hybrid bearings are much harder and stiffer than the all-steel bearings. Although this increased level of hardness and stiffness creates a higher degree of contact stress between the ceramic ball and the steel raceway, extensive experience and testing shows that in typical machine tool applications, the service life of hybrid bearing is significantly longer than that of all-steel bearing. The reasons for this are: 1) low density minimizes centrifugal and inertial forces; 2) low surface adhesive wear is reduced by the lower affinity to steel; and 3) better surface finish enables the bearing to maximize the effects of the lubricant.

References :

R. Barnsby, T. Harris, E. Ioannides, W. Littmann, T. Loesche, Y. Murakami, W. Needelman, H. Nixon, and M. Webster, "Life Ratings for Modern Rolling Bearings", ASME Paper 98-TRIB-57 (October 26, 1998).

T. A. Harris and M. H. Kotzalas, "Rolling Bearing Analysis: Advanced Concepts of Bearing technology", pp.209~258, 5th Ed., CRC Press, (2007).

5 Bearing Preload and Rigidity

5.1 Rigidity of spindle

System rigidity in machine tool applications is extremely important because the magnitude of deflection under load determines machining accuracy. Bearing rigidity is only one factor that influences system rigidity; others include shaft diameter, tool overhang, housing rigidity number, position and type of bearings. For axial rigidity of spindles, bearing rigidity plays an important role of it. Giving preload to a bearing result in the rolling element and raceway surfaces being under constant elastic compressive forces at their contact points. This has the effect of making the bearing extremely rigid so that even when load is applied to the bearing, radial or axial shaft displacement does not occur.

If high radial rigidity of bearing is needed, cylindrical roller bearings are normally used. In contrast to angular contact ball bearing, they provide more surface contact and gross sliding and are not suitable for very high-speed applications. For axial loading applications, angular contact ball bearings are normally used.

Their larger contact angle type provides higher axial rigidity. The rigidity of this type also depends on number and size of balls. Recently, the ceramic material silicon nitride Si₃N₄ is used for precision ball bearings. The radial rigidity of this hybrid bearing is approximately 15% higher because of the higher Young's modulus. As mentioned in 4.5, TPI's HS type angular contact ball bearings are optimally designed with their internal configuration to accommodate both low-ball skidding effect and high rigidity by using TH-BBAN.

5.2 Bearing Preload

The preload method is divided into fixed position preload and constant pressure preload as shown in Fig. 5.1. The fixed position preload is effective for positioning the two bearings and also for increasing the rigidity. Due to the use of a spring for the constant pressure preload, the preloading amount can be kept constant, even when the distance between the two bearings fluctuates under the influence of operating heat and load.

Fig. 5.1 Preloading methods for bearings
Fixed position preload



Constant pressure preload



The increased rigidity effect preloading has on bearings is shown in Fig. 5.2. When the offset inner rings of the two paired angular contact ball bearings are pressed together, each inner ring is displaced axially by the amount δ_{a0} and is thus given a preload, F_{a0} , in the direction. Under this condition, when external axial load F_a is applied, bearing A will have an increased displacement by the amount δ_{a0} and bearing B's displacement will decrease. At this time the loads applied to bearing

A and B are F_{aA} and F_{aB} , respectively. Under the condition of no preload, bearing A will be displaced by the amount δ_{aoA} when axial load F_a is applied. Since the amount of displacement, δ_a , is less than δ_{aoA} , it indicates a higher rigidity for δ_a . When external axial load F_a keeps increasing until δ_{aA} equals to $2\delta_{aoA}$, that is, $\delta_{aB}=0$. Now, bearing B becomes released from preload while bearing A is loaded with 2.83 times of given preload F_{a0} . This amount of load is called the limiting axial load and it may depend on bearing arrangement and contact angle.

Fig. 5.2 Fixed position preload versus axial displacement



due to interference fit between inner and shaft. Please contact TPI for further information.

There are four standard preloads: L (Light preload), N (Normal preload), M (Medium preload), and H (Heavy preload). These preload from light to heavy have certain ratio of dynamic basic load rating C_r . Table 5.1 is the preload comparison table of TPI bearings with other brand bearings for 7014C angular contact ball bearings. It is noted that preload setting methods may be different for other brand bearings. Table 5.9 shows standard preload, rigidity, and measured face side offset in DB and DF arrangement of various series of angular contact ball bearings. To stabilize the measurement of face side offset, measuring load is usually axially applied and listed in Table 5.2. As shown in Fig. 5.2, the true face side offset is $-2\delta_{aoA}$, while the measured face side offset in DB and DF arrangement as shown in Table 5.9 is compensated with measuring load. The positive and negative signs are defined in Appendix IV.

Table 5.10 shows standard preload and rigidity in DB and DF arrangement of BT and BS series of angular contact ball bearings.

Table 5.1 preload comparison table of TPI bearings with other brand bearings for 7014C

Brand Preload	TPI	NTN	NSK	FAG	SKF	GMN	Remark
Light	L(0.3)	L(0.2)	EL(0.3)	—	A(0.3)	—	7014C for instance, 0.3 in () means 0.3% C_r
Normal	N(0.6)	N(0.6)	L(0.6)	L(0.6)	B(0.8)	L(0.5)	
Medium	M(1.6)	M(1.2)	M(1.6)	M(1.8)	C(1.5)	M(1.5)	
Heavy	H(3.1)	—	H(3.1)	H(3.8)	—	S(3.0)	

5.2.1 Bearing standard preload

Universal combination bearings and matched bearing sets are produced in four different standard preload to meet the varying requirements including rotational speed, rigidity and heat generation. It is also needed to be aware that the proper preload during high-speed operation is important. Fig. 5.3 shows the factors may lead to preload change after installation and during operation. Among those factors, TPI may provide face side offset increase

Fig. 5.3 Preload setting study flow

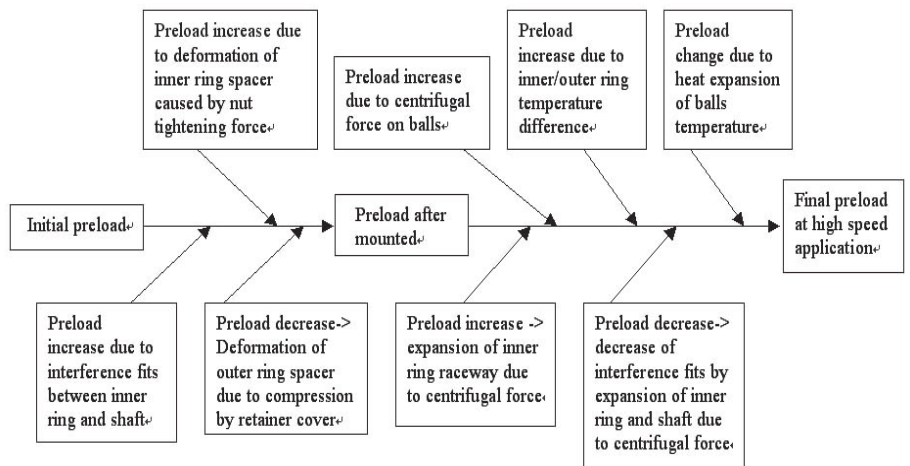

Table 5.2 Measuring load of face side offset

Nominal Outside Diameter (mm) D		Measuring load (N)
Over	Incl.	
10(incl.)	50	24.5
50	120	49
120	200	98

5.2.2 Individual adjustment of preload

In case where universal combination bearings or matched bearing sets are used, preload is determined at the factory during production. In some cases, however, it may be necessary to optimize the preload to accommodate operating conditions. It is possible to increase or decrease preload by using spacer rings between the bearings. For instance, in DB arrangement, reduce width of outer spacer rings should decrease preload while reduce width of inner rings should increase preload. In DF arrangement, reduce width of outer spacer rings should increase preload while reduce width of inner rings should decrease preload as shown in Fig. 5.4. By grinding the side face of the inner or outer spacer the preload in the bearing set can be changed. In these cases, the bearings should not be modified, as this requires special tools, and the bearings could be damaged. Table 5.3 provides information about which of the equal-width spacer ring side faces must be ground and what effect it will have. Table 5.9 contains the necessary dimensional deviation for the overall width of the spacer rings from deviation of measured face side offsets between two different standard preloads (positive value).

Table 5.3 Necessary spacer ring width reduction

Preload change	Width reduction (positive value)	Effect
N(Normal preload)-> L(Light preload)	(L preload)-(N preload)	Decrease preload
N(Normal preload)-> M(Medium preload)	(M preload)-(N preload)	Increase preload
N(Normal preload)-> H(Heavy preload)	(H preload)-(N preload)	Increase preload

Fig. 5.4 Increase or decrease preload by adjusting spacer ring width

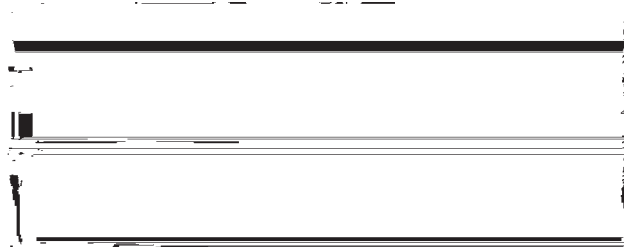

In the case of DT arrangement, it is necessary to remember that axial deflection δ_a of the combination bearings under preload is less than that of in DB and DF arrangement. Therefore, this difference has to be considered to the value of width reduction of spacer for altering preload as shown in Table 5.4.

Table 5.4 Axial deflection for No. of row in DT arrangement





No. of row in DT	1	2	3	4
Axial deflection	δ_a	0.63 δ_a	0.48 δ_a	0.40 δ_a

However, it is not necessary to determine axial deflection although it can be calculated once bearing arrangement and contact angle (including mixed contact angle) are designated for applications. As long as the bearing preload provides sufficient system rigidity, the resulting preload can be determined by a factor for its bearing arrangement as shown in Table 5.5. The value of resulting preload P_r is

$$P_r = P_1 \cdot P_{ro} \quad N$$

where P_{ro} can be obtained in Table 5.9

Table 5.5 Preload Factor P_1 for different bearing arrangements

Arrangement	Factor P_1
 DB	1.00
 DBT	1.35
 DTTB	1.60
 DTBT	2.00

5.3 Rigidity of angular contact ball bearing

Elastic deformation in rolling bearings results in the rings being displaced relative to each other. For angular contact ball bearings, the following formula is used to calculate this relative displacement in a radial and axial direction:



where δ_r : radial displacement under pure radial load, mm

- δ_a : axial displacement under pure axial load, mm
- F_r : pure radial load, kgf
- F_a : pure axial load, kgf
- i : No. of row
- Z : No. of balls per row
- D_w : ball pitch diameter, mm
- α : contact angle, degrees

In Table 5.9, the (axial) rigidity is defined as the external axial load of a bearing set in DB or DF arrangement, which causes a deflection of 1 micron of the bearing rings to each other. Before reaching to limiting axial load, bearing rigidity can be consistently measured and the result is close to the calculated value under light and normal preload. However, for bearings under medium and heavy preload, the calculated value becomes doubtful because of change of initial and final contact angles. The above formula for radial and axial displacements is not valid under heavy load and needs more rigorous analytical computer programs such as TH-BBAN to solve it.

Radial rigidity varies with contact angle and preload. In contrast to axial rigidity, radial rigidity decreases as contact angle increases and changes markedly as a function of the ratio between axial and external loads applied to the bearing. In practical manner, the radial and axial rigidity are determined as follows. Rigidity factors with various arrangements, contact angle, and preload in the formula can be obtained in Table 5.6 and 5.7.

$$R_r = q_1 \cdot q_2 \cdot R_a \quad \text{N/}\mu\text{m}$$

$$R_a = q_1 \cdot R_{a0}$$

where, q_1 : rigidity factor for bearing arrangement, please refer to Table 5.6

q_2 : rigidity factor for contact angle and preload, please refer to Table 5.7

Table 5.6 Rigidity factor for bearings with various arrangements q_1



Arrangement	Radial factor q_1	Axial factor q_1
 DB	1.00	1.00
 DBT	1.54	1.48
 DTBT	2.00	2.00

Table 5.7 Rigidity factor for bearings with various arrangement and preload q_2

Preload \ Contact angle	L	N	M	H
15°	6.5	6.0	5.0	4.5
18°	4.5			—
25°	2.0			
30°	1.4			

5.4 Limiting Axial Load

Limiting axial load is the external axial load of a preloaded bearing pair or set that causes loss of contact between the balls and race in preloaded bearings. This effect may lead to balls skidding against the raceways and surface damage.

In some machine tool applications, where the working axial load is predominantly in one direction, limiting axial load can be increased by using a bearing set with a mixed contact angle. The axially more rigid bearing withstands the workload and the less rigid one is the reaction element. Table 5.8 is an example to address the above concept. Compared to the bearing set with same contact angle, the bearing set with a mixed contact angle of 15 and 25 degrees withstands higher 5.9 times of axial preload load (compared to 2.83 times of preload). Furthermore, it could be considered that increasing their contact angle by 3~5 degree, bearings withstand their axial load may have 16 ~32% more limiting axial load and axial rigidity as well.

Table 5.8 Limiting axial load of bearings with an equal/a mixed contact angle and various arrangements

Unit : P_{ro} (N)



Arrangement	Limiting axial load			
	$\alpha_1 = \alpha_2$		$\alpha_1 = 25^\circ, \alpha_2 = 15^\circ$	
α contact angle 1: bearing withstands axial load; 2: bearing paired to bearing 1	P_{d1}	P_{d2}	P_{d1}	P_{d2}
 DB	2.83	2.83	5.90	1.75
 DBT	4.16	2.08	9.85	1.45
 DTTB	5.40	1.80	13.66	1.33
 DTBT	2.83	2.83	5.90	1.75

Table 5-9(1) Preload and Rigidity (DB and DF Arrangement) of 70C standard series

Bearing Number	Bearing Preload、Rigidity、and Measured Face Side Offset												
	Bore d (mm)	L			N			M			H		
		Preload P_{ro} (N)	Rigidity R_{ao} (N/ μ m)	Measured Offset (μ m)	Preload P_{ro} (N)	Rigidity R_{ao} (N/ μ m)	Measured Offset (μ m)	Preload P_{ro} (N)	Rigidity R_{ao} (N/ μ m)	Measured Offset (μ m)	Preload P_{ro} (N)	Rigidity R_{ao} (N/ μ m)	Measured Offset (μ m)
7000C	10	15	14	(2)	30	19	(-2)	85	30	(-10)	165	43	(-19)
7001C	12	15	14	(2)	35	19	(-2)	85	31	(-10)	170	43	(-19)
7002C	15	20	17	(1)	40	23	(-3)	100	37	(-11)	195	51	(-19)
7003C	17	20	19	(1)	40	25	(-3)	105	39	(-11)	205	55	(-19)
7004C	20	35	24	(-2)	65	32	(-6)	180	51	(-17)	345	71	(-28)
7005C	25	35	26	(-2)	70	35	(-6)	185	54	(-17)	360	76	(-28)
7006C	30	45	31	(0)	90	41	(-5)	240	64	(-16)	470	90	(-28)
7007C	35	55	36	(-1)	115	48	(-6)	305	75	(-19)	595	104	(-32)
7008C	40	60	40	(-1)	125	53	(-7)	330	83	(-19)	640	115	(-31)
7009C	45	75	44	(-2)	145	58	(-8)	390	90	(-21)	755	125	(-35)
7010C	50	80	48	(-3)	155	63	(-8)	415	99	(-21)	805	137	(-34)
7011C	55	100	53	(-5)	205	71	(-11)	545	110	(-26)	1060	152	(-42)
7012C	60	105	56	(-5)	210	74	(-11)	560	115	(-26)	1085	159	(-41)
7013C	65	110	61	(-5)	225	80	(-11)	595	124	(-26)	1150	172	(-41)
7014C	70	140	67	(-7)	280	88	(-14)	750	136	(-30)	1455	188	(-48)
7015C	75	145	69	(-7)	290	92	(-14)	770	141	(-30)	1490	195	(-47)
7016C	80	175	75	(-5)	350	99	(-13)	940	153	(-32)	1820	211	(-51)
7017C	85	180	78	(-5)	360	103	(-13)	965	158	(-31)	1865	218	(-50)
7018C	90	215	83	(-7)	430	109	(-16)	1145	169	(-36)	2220	233	(-58)
7019C	95	220	86	(-7)	440	114	(-15)	1175	175	(-36)	2280	241	(-57)
7020C	100	225	90	(-6)	450	118	(-15)	1205	182	(-35)	2335	250	(-56)

(70 series C angle:15° nominal contact angle, steel ball)

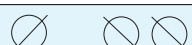
Table 5-9(2) Preload and Rigidity (DB and DF Arrangement) of 70AD standard series

Bearing Number	Bearing Preload、Rigidity、and Measured Face Side Offset												
	Bore d (mm)	L			N			M			H		
		Preload P_{ro} (N)	Rigidity R_{ao} (N/ μ m)	Measured Offset (μ m)	Preload P_{ro} (N)	Rigidity R_{ao} (N/ μ m)	Measured Offset (μ m)	Preload P_{ro} (N)	Rigidity R_{ao} (N/ μ m)	Measured Offset (μ m)	Preload P_{ro} (N)	Rigidity R_{ao} (N/ μ m)	Measured Offset (μ m)
7000AD	10	25	34	(0)	45	43	(-2)	140	67	(-9)	270	89	(-16)
7001AD	12	25	34	(0)	45	44	(-2)	140	67	(-9)	275	89	(-16)
7002AD	15	25	40	(0)	55	52	(-3)	160	80	(-9)	315	106	(-16)
7003AD	17	30	44	(0)	55	56	(-3)	170	86	(-9)	335	114	(-16)
7004AD	20	50	57	(-2)	95	73	(-5)	285	112	(-13)	565	149	(-21)
7005AD	25	50	61	(-2)	100	78	(-5)	300	120	(-13)	590	159	(-21)
7006AD	30	65	72	(-1)	130	93	(-4)	390	142	(-13)	765	188	(-22)
7007AD	35	80	85	(-2)	165	109	(-5)	490	166	(-15)	965	220	(-24)
7008AD	40	90	94	(-2)	175	121	(-5)	525	184	(-14)	1035	243	(-24)
7009AD	45	105	103	(-2)	210	132	(-6)	625	201	(-16)	1225	265	(-26)
7010AD	50	110	113	(-2)	220	145	(-6)	665	221	(-16)	1305	290	(-26)
7011AD	55	145	126	(-4)	290	162	(-8)	875	246	(-19)	1715	324	(-31)
7012AD	60	150	131	(-4)	300	169	(-7)	895	257	(-19)	1760	338	(-30)
7013AD	65	160	143	(-4)	315	184	(-7)	945	279	(-18)	1860	366	(-30)
7014AD	70	200	157	(-5)	400	202	(-9)	1200	306	(-22)	2355	402	(-35)
7015AD	75	205	163	(-5)	410	210	(-9)	1225	318	(-21)	2405	418	(-34)
7016AD	80	250	176	(-4)	500	227	(-9)	1500	343	(-23)	2945	451	(-37)
7017AD	85	255	184	(-4)	510	236	(-9)	1535	357	(-22)	3015	469	(-37)
7018AD	90	305	195	(-5)	610	251	(-10)	1830	380	(-26)	3595	499	(-42)
7019AD	95	315	203	(-5)	625	261	(-10)	1875	396	(-25)	3685	519	(-41)
7020AD	100	320	211	(-5)	640	272	(-10)	1920	411	(-25)	3775	538	(-41)

(70 series AD angle:25° nominal contact angle, steel ball)

Table 5-9 (3) Preload and Rigidity (DB and DF Arrangement) of 70 A standard series

Bearing number	Bore <i>d</i>	Bearing Preload, Rigidity, and Measured Face Side Offset								
		L			N			M		
		Preload <i>P_{ro}</i> (N)	Rigidity <i>R_{ao}</i> (N/μm)	Measured offset (μm)	Preload <i>P_{ro}</i> (N)	Rigidity <i>R_{ao}</i> (N/μm)	Measured offset (μm)	Preload <i>P_{ro}</i> (N)	Rigidity <i>R_{ao}</i> (N/μm)	Measured offset (μm)
7000A	10	20	39	(0)	65	59	(3)	130	77	(7)
7001A	12	20	39	(0)	66	60	(3)	131	78	(7)
7002A	15	20	44	(0)	75	71	(3)	151	93	(7)
7003A	17	20	47	(0)	79	76	(3)	158	99	(7)
7004A	20	40	65	(1)	134	100	(5)	268	130	(10)
7005A	25	40	65	(1)	140	108	(5)	281	140	(9)
7006A	30	50	80	(0)	181	128	(5)	361	166	(9)
7007A	35	65	94	(0)	228	150	(6)	455	194	(10)
7008A	40	65	102	(0)	237	164	(5)	473	213	(10)
7009A	45	80	114	(1)	293	181	(6)	585	231	(12)
7010A	50	85	125	(1)	308	198	(6)	616	256	(11)

(70 series A angle:30° nominal contact angle, steel ball)

Table 5-9 (4) Preload and Rigidity (DB and DF Arrangement) of 5S1-70C standard series

Bearing Number	Bore <i>d</i> (mm)	Bearing Preload, Rigidity, and Measured Face Side Offset											
		L			N			M			H		
		Preload <i>P_{ro}</i> (N)	Rigidity <i>R_{ao}</i> (N/μm)	Measured Offset (μm)	Preload <i>P_{ro}</i> (N)	Rigidity <i>R_{ao}</i> (N/μm)	Measured Offset (μm)	Preload <i>P_{ro}</i> (N)	Rigidity <i>R_{ao}</i> (N/μm)	Measured Offset (μm)	Preload <i>P_{ro}</i> (N)	Rigidity <i>R_{ao}</i> (N/μm)	Measured Offset (μm)
5S1-7000C	10	20	17	(1)	40	23	(-3)	100	36	(-11)	195	51	(-20)
5S1-7001C	12	20	17	(1)	40	23	(-3)	105	37	(-11)	200	52	(-20)
5S1-7002C	15	25	21	(0)	45	28	(-3)	120	44	(-12)	230	61	(-20)
5S1-7003C	17	25	22	(0)	50	30	(-4)	125	47	(-12)	245	66	(-20)
5S1-7004C	20	40	29	(-2)	80	39	(-7)	210	61	(-18)	410	85	(-29)
5S1-7005C	25	45	31	(-3)	85	41	(-7)	220	65	(-18)	430	90	(-28)
5S1-7006C	30	55	37	(-1)	110	49	(-6)	285	76	(-17)	555	107	(-29)
5S1-7007C	35	70	43	(-2)	135	57	(-7)	360	89	(-20)	705	124	(-33)
5S1-7008C	40	75	48	(-2)	145	63	(-8)	390	98	(-20)	755	137	(-32)
5S1-7009C	45	90	52	(-3)	175	69	(-9)	460	107	(-22)	895	149	(-36)
5S1-7010C	50	95	57	(-4)	185	76	(-9)	490	117	(-22)	955	162	(-35)
5S1-7011C	55	125	63	(-5)	245	84	(-12)	645	131	(-27)	1255	181	(-43)
5S1-7012C	60	125	66	(-5)	250	88	(-12)	665	136	(-27)	1290	188	(-42)
5S1-7013C	65	135	72	(-5)	265	96	(-12)	705	147	(-26)	1370	204	(-41)
5S1-7014C	70	170	79	(-7)	335	105	(-15)	890	162	(-31)	1730	224	(-49)
5S1-7015C	75	175	82	(-7)	345	109	(-15)	915	168	(-31)	1775	232	(-48)
5S1-7016C	80	215	89	(-6)	420	118	(-14)	1120	181	(-33)	2170	250	(-52)
5S1-7017C	85	220	92	(-6)	430	123	(-14)	1145	188	(-32)	2225	260	(-51)
5S1-7018C	90	260	98	(-7)	515	131	(-17)	1365	200	(-37)	2645	276	(-58)
5S1-7019C	95	270	102	(-7)	530	136	(-17)	1405	208	(-37)	2715	287	(-58)
5S1-7020C	100	275	106	(-7)	540	140	(-16)	1435	216	(-36)	2780	297	(-57)

(5S1-70 series C angle:15° nominal contact angle, ceramic ball)

Table 5-9 (5) Preload and Rigidity (DB and DF Arrangement) of HSCE1 standard series

Bearing Number	Bearing Preload、Rigidity、and Measured Face Side Offset												
	Bore d (mm)	L			N			M			H		
		Preload P_{ro} (N)	Rigidity R_{ao} (N/ μ m)	Measured Offset (μ m)	Preload P_{ro} (N)	Rigidity R_{ao} (N/ μ m)	Measured Offset (μ m)	Preload P_{ro} (N)	Rigidity R_{ao} (N/ μ m)	Measured Offset (μ m)	Preload P_{ro} (N)	Rigidity R_{ao} (N/ μ m)	Measured Offset (μ m)
HS000CE1	10	5	12	(5)	10	15	(3)	30	22	(-1)	60	29	(-5)
HS001CE1	12	5	12	(5)	10	15	(3)	30	22	(-1)	55	29	(-5)
HS002CE1	15	10	15	(4)	15	19	(2)	40	28	(-3)	80	36	(-7)
HS003CE1	17	10	16	(3)	15	20	(2)	40	29	(-3)	80	38	(-7)
HS004CE1	20	15	21	(2)	25	27	(0)	70	39	(-5)	130	51	(-11)
HS005CE1	25	15	22	(2)	25	28	(0)	70	41	(-5)	135	53	(-11)
HS006CE1	30	30	30	(3)	55	38	(-1)	150	55	(-8)	290	72	(-17)
HS007CE1	35	35	33	(2)	70	43	(-2)	185	61	(-11)	355	80	(-20)
HS008CE1	40	35	37	(1)	75	47	(-2)	195	67	(-11)	380	88	(-20)
HS009CE1	45	40	40	(1)	75	52	(-3)	205	73	(-10)	400	95	(-20)
HS010CE1	50	45	44	(0)	95	57	(-4)	250	81	(-12)	485	105	(-23)
HS011CE1	55	50	49	(0)	100	62	(-3)	270	90	(-12)	520	117	(-22)
HS012CE1	60	50	51	(0)	105	64	(-3)	275	93	(-12)	530	121	(-22)
HS013CE1	65	60	56	(-1)	120	70	(-5)	325	102	(-14)	630	132	(-24)
HS014CE1	70	70	60	(-1)	145	76	(-5)	380	110	(-15)	740	143	(-27)
HS015CE1	75	80	68	(-2)	155	86	(-6)	420	125	(-16)	810	163	(-27)
HS016CE1	80	105	74	(0)	205	96	(-5)	545	140	(-16)	1060	182	(-29)
HS017CE1	85	105	76	(0)	210	99	(-5)	555	144	(-16)	1080	188	(-29)
HS018CE1	90	110	81	(0)	215	105	(-5)	575	153	(-16)	1120	199	(-28)
HS019CE1	95	135	87	(-1)	265	112	(-7)	710	163	(-20)	1375	213	(-34)
HS020CE1	100	135	89	(-1)	270	116	(-7)	725	168	(-19)	1400	219	(-33)

(HS series CE1 angle:18° nominal contact angle, steel ball)

Table 5-9 (6) Preload and Rigidity (DB and DF Arrangement) of 5S1-HSCE1 standard series

Bearing Number	Bearing Preload、Rigidity、and Measured Face Side Offset												
	Bore d (mm)	L			N			M			H		
		Preload P_{ro} (N)	Rigidity R_{ao} (N/ μ m)	Measured Offset (μ m)	Preload P_{ro} (N)	Rigidity R_{ao} (N/ μ m)	Measured Offset (μ m)	Preload P_{ro} (N)	Rigidity R_{ao} (N/ μ m)	Measured Offset (μ m)	Preload P_{ro} (N)	Rigidity R_{ao} (N/ μ m)	Measured Offset (μ m)
5S1-HS000CE1	10	5	14	(4)	15	18	(2)	35	26	(-2)	70	34	(-6)
5S1-HS001CE1	12	5	14	(4)	15	18	(2)	35	26	(-2)	70	34	(-6)
5S1-HS002CE1	15	10	18	(3)	20	23	(1)	50	33	(-3)	95	43	(-8)
5S1-HS003CE1	17	10	18	(3)	20	24	(1)	50	34	(-3)	95	45	(-8)
5S1-HS004CE1	20	15	25	(1)	30	32	(-1)	80	47	(-6)	155	61	(-11)
5S1-HS005CE1	25	15	26	(1)	30	34	(-1)	80	48	(-6)	160	63	(-11)
5S1-HS006CE1	30	35	36	(2)	70	46	(-2)	175	65	(-9)	345	86	(-18)
5S1-HS007CE1	35	40	40	(1)	85	51	(-3)	215	73	(-11)	425	96	(-21)
5S1-HS008CE1	40	45	44	(0)	90	56	(-3)	230	80	(-11)	455	105	(-21)
5S1-HS009CE1	45	45	48	(0)	95	62	(-3)	245	87	(-11)	490	115	(-21)
5S1-HS010CE1	50	55	52	(-1)	115	67	(-4)	300	96	(-13)	580	125	(-24)
5S1-HS011CE1	55	60	58	(-1)	115	73	(-4)	320	107	(-13)	630	140	(-23)
5S1-HS012CE1	60	60	60	(-1)	120	75	(-4)	325	111	(-13)	630	143	(-22)
5S1-HS013CE1	65	75	67	(-1)	145	84	(-5)	385	121	(-14)	745	156	(-25)
5S1-HS014CE1	70	90	73	(-2)	170	91	(-6)	455	131	(-16)	880	170	(-27)
5S1-HS015CE1	75	100	82	(-3)	190	102	(-6)	495	148	(-16)	970	195	(-28)
5S1-HS016CE1	80	120	88	(-1)	245	114	(-6)	650	166	(-17)	1260	217	(-30)
5S1-HS017CE1	85	125	91	(-1)	250	118	(-6)	660	171	(-17)	1280	223	(-30)
5S1-HS018CE1	90	125	96	(-1)	260	125	(-6)	685	181	(-17)	1330	237	(-29)
5S1-HS019CE1	95	160	103	(-2)	315	133	(-7)	840	193	(-20)	1635	253	(-34)
5S1-HS020CE1	100	160	106	(-2)	325	137	(-7)	860	200	(-20)	1665	260	(-34)

(5S1-HS series CE1 angle:18° nominal contact angle, ceramic ball)

Table 5-9 (7) Preload and Rigidity (DB and DF Arrangement) of 72C standard series

Bearing Number	Bearing Preload \ Rigidity \ and Measured Face Side Offset												
	Bore d (mm)	L			N			M			H		
		Preload P_{ro} (N)	Rigidity R_{ao} (N/μm)	Measured Offset (μm)	Preload P_{ro} (N)	Rigidity R_{ao} (N/μm)	Measured Offset (μm)	Preload P_{ro} (N)	Rigidity R_{ao} (N/μm)	Measured Offset (μm)	Preload P_{ro} (N)	Rigidity R_{ao} (N/μm)	Measured Offset (μm)
7200C	10	15	14	(2)	30	19	(-2)	85	31	(-10)	170	43	(-19)
7201C	12	20	17	(1)	40	22	(-4)	115	35	(-14)	220	49	(-24)
7202C	15	25	19	(-1)	55	25	(-5)	145	40	(-17)	280	56	(-28)
7203C	17	35	21	(-2)	65	28	(-7)	180	44	(-20)	345	62	(-32)
7204C	20	45	25	(-3)	85	34	(-9)	235	53	(-23)	450	75	(-36)
7205C	25	50	30	(0)	100	40	(-6)	265	62	(-19)	515	87	(-32)
7206C	30	70	35	(-2)	140	47	(-9)	370	74	(-24)	715	103	(-40)
7207C	35	90	40	(-5)	180	54	(-12)	485	85	(-30)	940	118	(-48)
7208C	40	110	46	(-6)	220	62	(-14)	580	96	(-33)	1125	134	(-51)
7209C	45	120	49	(-7)	245	66	(-16)	655	102	(-35)	1265	142	(-55)
7210C	50	130	52	(-7)	255	70	(-16)	685	109	(-35)	1325	151	(-55)
7211C	55	160	58	(-9)	320	78	(-18)	845	121	(-40)	1640	167	(-62)
7212C	60	190	64	(-11)	385	86	(-21)	1025	132	(-45)	1985	184	(-69)
7213C	65	210	67	(-12)	420	90	(-23)	1115	138	(-47)	2165	192	(-72)
7214C	70	230	70	(-8)	455	93	(-20)	1215	144	(-45)	2355	200	(-72)
7215C	75	240	74	(-9)	475	99	(-20)	1270	153	(-45)	2460	212	(-71)
7216C	80	280	80	(-10)	555	107	(-22)	1485	165	(-49)	2875	229	(-78)
7217C	85	310	88	(-11)	625	118	(-24)	1665	181	(-51)	3230	251	(-80)
7218C	90	370	92	(-14)	735	124	(-28)	1960	190	(-59)	3800	263	(-91)
7219C	95	415	98	(-16)	835	132	(-31)	2220	203	(-64)	4305	280	(-98)
7220C	100	445	98	(-17)	895	132	(-33)	2385	203	(-69)	4620	280	(-106)

(72 series C angle:15° nominal contact angle, steel ball)

Table 5-10(1) Preload and Rigidity (DB and DF Arrangement) of BT A standard series

Bearing Number	Bore d (mm)	Bearing Preload \ Rigidity			
		M		H	
		Preload P_{ro} (N)	Rigidity R_{ao} (N/μm)	Preload P_{ro} (N)	Rigidity R_{ao} (N/μm)
BT010A DB	50	325	190	650	243
BT011A DB	55	347	212	695	272
BT012A DB	60	352	219	704	280
BT013A DB	65	421	240	841	307
BT014A DB	70	492	260	984	332
BT015A DB	75	499	268	998	343
BT016A DB	80	653	301	1306	384
BT017A DB	85	663	310	1326	396
BT018A DB	90	686	329	1372	421
BT019A DB	95	848	352	1695	449
BT020A DB	100	861	362	1722	463

Table 5-10(2) Preload and Rigidity (DB and DF Arrangement) of BT B standard series

Bearing Number	Bore d (mm)	Bearing Preload \ Rigidity			
		M		H	
		Preload P_{ro} (N)	Rigidity R_{ao} (N/μm)	Preload P_{ro} (N)	Rigidity R_{ao} (N/μm)
BT010B DB	50	540	339	1080	431
BT011B DB	55	576	378	1152	481
BT012B DB	60	582	390	1165	496
BT013B DB	65	697	427	1393	543
BT014B DB	70	815	463	1630	589
BT015B DB	75	826	478	1651	607
BT016B DB	80	1082	536	2164	681
BT017B DB	85	1098	553	2196	702
BT018B DB	90	1134	587	2269	745
BT019B DB	95	1404	627	2808	797
BT020B DB	100	1426	646	2851	821

Table 5-10(3) Preload and Rigidity (DB and DF Arrangement) of BS standard series

Bearing Number	Bore d (mm)	Bearing Preload \ Rigidity	
		Preload P_{ro} (N)	Rigidity R_{ao} (N/ μ m)
BS1747	17	2060	635
BS2047	20	2060	635
BS2562	25	3250	980
BS3062	30	3250	980
BS3572	35	3800	1130
BS4072	40	3800	1130
BS4090	40	7050	1470
BS4575	45	4200	1230
BS50100	50	8250	1720
BS60120	60	9900	2010

6 Bearing Lubrication

The purpose of bearing lubrication is to prevent direct metal-to-metal contact between the various rolling and sliding elements. This is accomplished through the formation of a thin oil (or grease) film on contact surfaces. Lubrication also helps to reduce friction and wear, dissipate friction heat, keep away from dust. In order to achieve the above advantages and prolong the bearing life, the most effective lubrication method and lubricant has to be selected for each individual operating condition.

The machine tool spindle keeps the amount of lubricant at minimal and no more than that required to ensure lubricating to avoid heat generation. The relationship between oil quantity, heat generation, and bearing temperature rise is summarized in Fig.6.1.

There are several lubrication methods such as grease lubrication, oil mist lubrication, air-oil lubrication, and jet lubrication for bearings in a machine tool include. Each method has its advantages and disadvantages. It is aware that grease lubrication is being used increasingly not only because it is simple and inexpensive but also because it is environmental friendly.

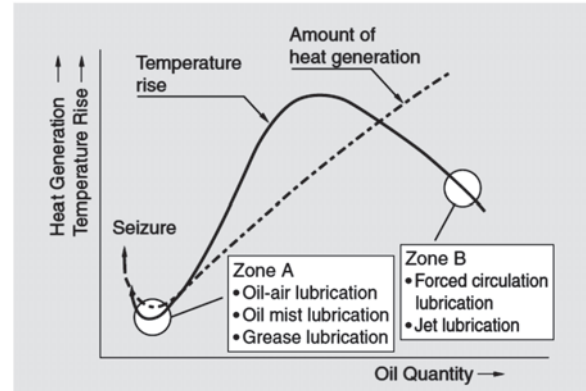
Fig. 6.1 Oil quantity, heat generation, and temperature rise

6.1 Grease Lubrication and Its Life Prediction

Lubricating grease is composed of either a mineral oil base or a synthetic oil base. To this base a thickener and other additives are added. Thickening agents are compounded with base oils to maintain the semi-solid state of the grease.

When lubricating bearings in high-speed machine tool spindle, the amount of grease supplied should be no more than that required to ensure lubricating, if the temperature is to be kept as low as possible. The following guideline for the amount of grease used for spindles is given below.

- Angular contact ball bearing: 20~25% of bearing free space. The higher speed or dmn value, the less the grease amount filled. Please consult TPI.
- Deep groove ball bearing bearing: 30% of bearing free space

The free space in a bearing typically used for main spindles are listed in dimension tables. One may determine the amount of grease filled accordingly.

For ball screw support applications, support bearings are generally lubricated by grease. The recommended grease is listed in Table 6.1 and amount of grease is 25% of bearing free space.

Table 6.1 Typical greases for machine tool main spindle bearings

Code	Grease brand	Thickner	Base oil	Base oil viscosity (40°C) mm2/S	Dropping point (°C)	NLGI	Operating temperature range (°C)	Characteristics
5K	Multemp SRL	Li	ester	26	201	2	-40~+150	General used, low noise
12K	Multemp LRL NO3	Li	ester	30	>200	2	-40~+150	High speed Ball screw support
15K	Isoflex NBU 15	Ba Complex	ester+ PAO+mineral	20	>200	2	-40~+130	High speed
L712	Kluberspeed BF 72-22	Urea	ester+ PAO	22	220	2	-50~+120	High speed
L433	Asonic Q 74-73	Urea	ester+ PAO	68	>250	3	-40~+160	High speed
L559	Turmogrease High speed L252	Li	ester	25	>250	2	-40~+150	High speed
2AS	Alvania Grease S2	Li	mineral	130	>200	2	-25~+120	Ball screw support

The prediction of grease life can be calculated according to the method of Kawamura et al. The calculated life L_{50} (50% reliability life) of grease can be expressed as follows:

For urea-based grease :

$$\log L = -2.02 \times 10^{-6} \times K \times V - 2.95 \times 10^{-2} T - 8.36 F + 8.50 + K_1 \cdot \dots (7-1)$$

where,

$$10 \leq dm \leq 100, dmn \leq 400000, 70 \leq T \leq 180$$

For **Li-based** grease :

$$\log L = -1.58 \times 10^{-6} \times K \times V - 2.18 \times 10^{-2} T - 9.84 F + 6.33 + K_1 \cdot \dots (7-2)$$

where,

$$10 \leq dm \leq 100, dmn \leq 400000, 70 \leq T \leq 150$$

L : L_{50} grease life, hour

K : compensation factor for outer ring rotation (if inner ring rotation: $K=1$; if outer ring rotation: $K=$ inner ring rotating speed calculated from the cage orbital speed when inner ring rotation condition is assumed/ outer ring rotating speed)

V : dmn value (Definition refer to 9.2)

$$dm : \text{pitch diameter} \approx \frac{d + D}{2}$$

D : outside diameter mm

T : bearing temperature °C

F : load ratio P/Cr

K_1 : compensation factor for base oil type (Table 6.2, 6.3)

Table 6.2 K_1 value for urea based grease

Base oil type	compensation factor K_1
mineral	-0.08
PAO	-0.05
ester	-0.21
ether	0.18
mineral +PAO	-0.06
mineral + ester	-0.16
PAO+ ester	0
PAO+ ether	0
ester + ether	0.07

Table 6.3 K_1 value for Lithium based grease

Base oil type	compensation factor K_1
mineral	-0.29
PAO	-0.05
ester	0.42
diester	-0.5
silicon	0.54

6.2 Air-oil Lubrication

Air-oil lubrication provides specific as well as volume-regulated lubricant delivery to the rolling and sliding surfaces in the bearing. The oil is transported by means of an air stream that form streaks along the inner wall of the transparent supply hose and released uniformly at lubricating points at specified intervals. Air-oil lubrication provides utmost effectiveness with respect to consumption and lubricating effect at maximum speeds.

The oil nozzles should be positioned correctly. A nozzle with a hole diameter of 1.0 to 1.5 mm and a length 4 to 6 times the hole diameter is recommended. Air-oil lubrication requires a specialized nozzle because it supplies the lubricating oil to the inside of the bearing by means of compressed air. Fig. 6.2 illustrates the feed system for air-oil lubrication when lubricant is supplied between the cage and inner ring. Table 6.4 shows the Air-oil/oil mist nozzle spacer dimension.

Fig. 6.2 Feed system for air-oil lubrication

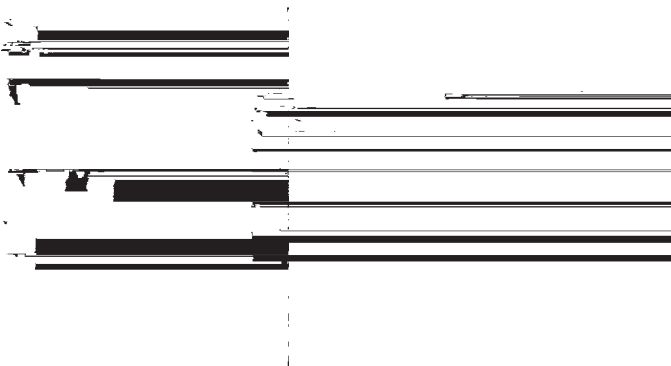

Table 6.4 Air-oil/oil mist nozzle spacer dimensions

Unit : mm

Bearing No.	S	ϕA
HS000CE1	0.80	19.15
HS001CE1	1.15	22.20
HS002CE1	1.10	25.65
HS003CE1	1.00	28.00
HS004CE1	1.20	33.10
HS005CE1	1.20	38.10
HS006CE1	1.20	42.30
HS007C E1	1.38	48.33
HS008C E1	1.33	53.68
HS009CE1	1.33	59.68
HS010CE1	1.58	64.93
HS011CE1	1.58	72.43
HS012CE1	1.58	77.43

HS013CE1	1.68	82.33
HS014CE1	1.68	89.33
HS015CE1	1.88	94.93
HS016CE1	2.28	102.63
HS017CE1	2.28	107.63
HS018CE1	2.28	115.13
HS019CE1	2.47	119.82
HS020CE1	2.47	124.82

6.3 Jet Lubrication

Oil jet is preferred for bearings having to operate at very high speed and high load. This is the most reliable lubricating technique and is typically used on the main spindle bearings of jet engines and gas turbines.

When used as a lubricating system for the main spindle of a machine tool, the amount of oil crossing the bearings also removes the heat generated by bearing operation and maintains overall temperature at acceptable levels. However, the resultant torque loss is great, as a large amount of oil which is low viscosity oil (ISO standards VG10 or VG15) is supplied to each bearing.

7 Bearing Limiting Speed

7.1 Bearing Limiting Speed

Angular contact ball bearings feature the highest rotational speed capabilities of all precision bearings. The limiting speeds listed in the precision bearing tables are guideline values. They are based on a single bearing that is lightly spring preloaded and subject to both grease and air-oil lubrication. In situations where the lubricant is used as a mean to remove heat, higher speed can be achieved. Limiting temperature for grease-lubricated bearings is lower than that for oil because of greater lubricant deterioration. Therefore, limiting speed for grease lubrication is consequently about 75% of the value achievable with oil.

Achievement of maximum speed is affected by internal configuration and correct assembly of the bearings. For bearing internal configuration, bearing arrangement, preload, bearing precision, contact angle and way of lubrication may influence bearing speed. Also, tolerance limits of shaft, housing, and spindle components, proper dynamic balancing of rotating parts, and efficient lubrication are external.

Accordingly, the limiting speed calculation can be performed based on the above consideration and the speed n_{max} is calculated as follows:

$$n_{max} = f_1 \cdot f_2 \cdot f_3 \cdot n_L \text{ min}^{-1}$$

where , f_1 : Speed factor for bearing arrangement v.s. preload, refer to Fig. 7.1

f_2 : Speed factor for bearing precision, refer to Table 7.1

f_3 : Speed factor for contact angle, refer to Table 7.2

n_L : The limiting speed for grease and oil lubrications, refer to Precision Bearing Tables

Fig. 7.1 Speed factor for bearing with various arrangements and preload f_1

Bearing arrangement		L	N	M	H
	DB	0.80	0.75	0.65	0.50
		/	/	/	/
	DBT	0.85	0.80	0.70	0.55
		/	/	/	/
	DTBT	0.65	0.60	0.50	0.30
		/	/	/	/
	DTBT	0.75	0.70	0.55	0.40
		/	/	/	/
	DTBT	0.70	0.65	0.50	0.30
		/	/	/	/
	DTBT	0.80	0.75	0.60	0.45
		/	/	/	/

Table 7.1 Speed factor for bearing precision f_2

Precision	Factor for precision		
	P2	P4	P5
f_2	1.1	1.0	0.9

Table 7.2 Speed factor for contact angle f_3

Contact angle	Factor for contact angle			
	15°	18°	25°	30°
f_3	1.00	0.97	0.86	0.73

When a ceramic ball is used, limiting speed value will be 1.25 times the value of steel ball. If the ball guided polyamide resin cage is used, the limiting speed is limited to 1.4 million dmN values.

The limiting speed for ball screw support BS thrust bearings is different from that for angular contact ball bearings. It accounts for the discrepancy for contact angle and preload between two types of bearings. The speed factor of limiting speed n_{max} for BS bearings are listed in Table 7.3.

Table 7.3 Speed factors for BS bearings f_1, f_2, f_3

Arrangement	DF DB	DFT DBT	DTFT DTBT
	f_1	0.58	0.52
Precision	P4		P5
f_2	1.0		0.9
Contact angle	60°		
f_3	1.00		

Same as BS bearings, high-speed thrust BT bearings have their own limiting speed calculation. The speed factor of limiting speed n_{max} for BT DB combined bearings are listed in Table 7.4. & 7.5

Table 7.4 Speed factors for BT DB combined bearings f_1, f_2

Preload	M	H
f_1	1.0	0.85
Precision	P4	P5
f_2	1.0	0.9

Table 7.5 Speed factor for BT DB bearing contact angle f_3

Contact angle	30	40
f_3	1.00	0.86

7.2 Friction

One of the main functions required of a bearing is that it must have low friction. Under normal operating conditions rolling bearings have a much smaller friction coefficient than the slide bearings, especially starting friction.

The friction coefficient for rolling bearings is calculated on the basis of the bearing bore diameters and is expressed by formula

$$M = \mu P \frac{d}{2}$$

where ,

M : Friction moment, N · mm or kgf · mm

μ : Friction coefficient, N · mm

P : Load, N or kgf

d : Bearing bore diameter, mm

Although the dynamic friction coefficient for rolling

bearings varies with the type of bearings, load,

lubrication, speed, and other factors; for normal operating conditions, the approximate friction coefficients for various bearing types are listed in Table 7.6.

Table 7.6 Friction coefficient for bearings

Bearing type	Coefficient $\times 10^{-3}$
Deep groove ball bearings	1.0 ~ 1.5
Angular contact ball bearings	1.2 ~ 1.8
Self-aligning ball bearings	0.8 ~ 1.2
Cylindrical roller bearings	1.0 ~ 1.5
Needle roller bearings	2.0 ~ 3.0
Tapered roller bearings	1.7 ~ 2.5
Spherical roller bearings	2.0 ~ 2.5
Thrust ball bearings	1.0 ~ 1.5
Thrust roller bearings	2.0 ~ 3.0

8 Bearing Handling

8.1 Cleaning and filling with grease

Handling the precision rolling bearing correctly is a vital step to achieve maximum speed and limited temperature rise. The handling of bearings involves cleaning, drying, filling with grease (if necessary), and the running-in operation.

For each step, please take precaution and follow the below description:

The cleaning step removes the rust-preventive oil. First, immerse the bearing in kerosene or a highly volatile solvent such as naphthosol. Wash the bearing carefully by hand and then remove the kerosene using benzene or alcohol. Use clean compressed air to blow away the rinsing fluid. (After cleaning, coating the bearing with the lubricant to be used or less viscous oil for jet-oil lubrication, or immersing the bearing in lubricant or other low-viscosity oil is recommended.)

If the bearing is to be used with grease lubrication, the bearing should be dried thoroughly to avoid leakage of grease. Fill the bearing with grease immediately after drying. Drying can be achieved by blowing hot air onto the bearing or placing the bearing in a chamber at constant temperature. When drying with hot air, please make sure the air is clean.

For greasing ball and roller bearings please refer to the procedure shown below. For ball bearings, use an injector or small plastic bag, aiming at the inner ring rolling surface, and carefully apply grease between balls in equal amounts. For bearings with ring-guided cage, also apply grease to the guide surface of the cage

using a spatula or similar tool. If grease cannot be added into the inner ring raceway due to the small gap between the cage and the inner ring, add grease to the outer ring raceway. In this case, turn the bearing so that the grease is fully spread on the inner ring side.

For roller bearings, apply grease to the outer or inner side of rollers, while turning the rollers to spread the grease to the opposite side. If a lump of grease remains on the outer face of cage rib, the running-in operation may take a longer time

8.2 Running In

For oil lubrication, the running-in operation is relatively simple with oil lubrication because no peak temperature occurs and the bearing temperature stabilizes within a relatively short time. TPI recommends that the speed of bearing is to be increased in steps of 2000 to 3000 min⁻¹ until the maximum speed is reached. Every speed setting should be maintained for about 30 minutes. However, for the speed range where the dmN (pitch circle diameter across rolling elements multiplied by speed) exceeds 1,000,000, increase the bearing speed in steps of 1000 to 2000 min⁻¹ to ensure the stable running.

For a grease-lubricated bearing, a running-in operation is very important in attaining stable temperature rise. During a running-in operation, a large temperature rise (peak) occurs while the bearing speed is increased, and then the bearing temperature eventually stabilizes. Before temperature stabilization, a certain lead-time will be needed. For ball bearing, TPI recommends that the bearing speed be increased in steps of 1000 to 2000 min⁻¹ and be further increased only after the temperature has stabilized at the current speed setting. However, for the speed range where the dmN exceeds 400,000, increase the bearing speed in steps of 500 to 1000 min⁻¹ to ensure the stable running. Compared with contact ball bearings, the time to peak temperature or saturation in running-in operation of roller bearings tends to be longer. Also, there will be temperature rise due to whipping of the grease and the temperature rise may be unstable. To cope with this problem, run the roller bearing in the maximum speed range for a prolonged period.

Increase the bearing speed in steps of 500 to 1000 min⁻¹ only after the bearing temperature has stabilized at the current speed setting. For the speed range where the dmN exceeds 300,000, increase the bearing speed in steps of 500 min⁻¹ to ensure safety.

As shown in Fig.8.1, bearing speed is increased gradually in steps. As soon as the temperature becomes saturated at each speed setting, the speed is increased to the next step.

Fig. 8.1 The bearing speed is gradually increased in steps

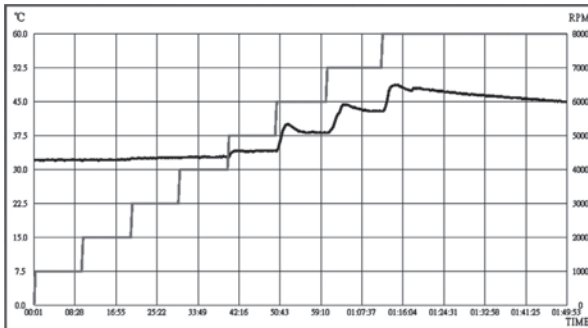

8.3 Mounting

There are several mounting techniques such as press fitting with hydraulic press, heating bearings with heater, and cool-shrinking shaft with liquid nitrogen. It is essential to minimize the adverse effects caused by mounting and maintain bearing accuracy.

If press-fitting a bearing with a hydraulic press is chosen, the press-fitting force due to the interference between the shaft and inner ring must be calculated. Next, using an inner ring press-fitting jig, the inner ring is correctly press-fitted to the shoulder of shaft. Please be careful not to exert a force on the outer ring.

For spindle applications, precision bearings are tightly fitted with a shaft. Induction heater is frequently used to heat the bearing bore and mount to the shaft correctly in position and instantly before shrinking back the original size. According to the thermal expansion coefficient 12.5×10^{-6} , it is easy to calculate interference fit $\delta = 12.5 \times 10^{-6} \times \phi d \times \Delta T$, where ΔT is heating temperature minus room temperature and ϕd is inner ring bore diameter. In reality, the low temperature shaft tends to lower the bearing and causes it to shrink during mounting. It is suggested that the heating temperature to be set is more than calculated temperature. If a bearing has resin cage, the suggested temperature need s to be 80° C or less.

When the bearing temperature drops to room temperature, the inner ring will shrink axially, and there will be a gap between the bearing side face and shaft shoulder illustrated in Fig. 8.2. For this reason, push the bearing and shaft together with a press until the unit returns to normal temperature. After cooling, check that the bearing is mounted to the shaft correctly.

Fig. 8.2 Cooling after mounting by heating bearings

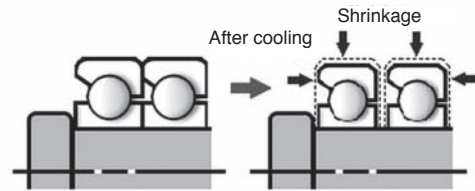

8.4 Tightening of Inner and Outer Ring

In order to mount and secure a bearing to a main spindle when it rotates, the inner ring side face is usually clamped with a precision bearing nut, and the front cover situated on the outer ring side face is bolted down.

Tightening with a precision bearing nut (precision locknut) provides a predetermined tightening force by controlling the bearing torque shown in Fig 8.3. When locking the bearing with a precision bearing nut, make sure that the squareness between the bearing surface and the shaft centerline is 3 μm or less so that adequate bearing accuracies are maintained.

Fig. 8.3 Tightening with precision bearing nut

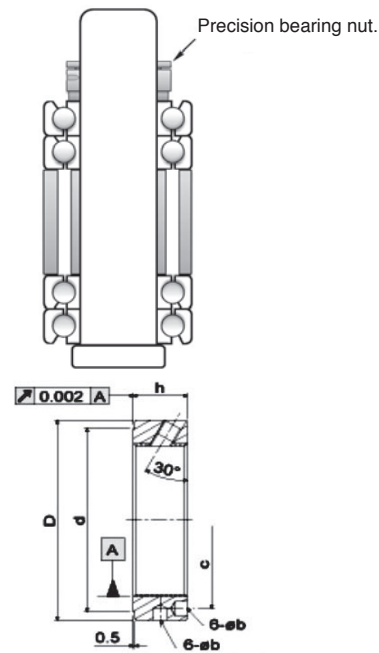

Because the thread face of the precision bearing nut, the thread face of the shaft and the bearing surface and nut constitute sliding surfaces, the correlation between tightening torque and tightening force will vary depending on the friction coefficient. The nut tightening force refer to Table 8.1. Therefore, the nut needs to be thoroughly run on the shaft thread in advance to ensure smooth and uniform tightening. It is also necessary to determine the correlation between tightening torque and tightening force by using a load washer or force device.

$$F = \frac{M}{(d/2) / \tan(\beta + \rho) + \gamma_n \mu_n}$$

- F : Thread tightening force N
- M : Nut tightening torque N.mm
- d : Effective diameter of thread mm
- ρ : Friction angle of thread face
- $\tan \rho = \frac{\mu}{\cos \alpha}$
- β : Lead angle of thread
- $\tan \beta = \frac{\text{number of threads} \sim \text{pitch}}{\pi d}$
- γ_n : Average radius of bearing nut surface mm
- μ_n : Friction coefficient of bearing nut surface
 $\mu_n 0.15$
- μ : Friction coefficient of thread face
- α : Half angle of thread

As shown in Fig. 8.4, the gap for front cover pressing allowance may vary depending upon its bearing bore diameter. The front cover is assembled by utilizing bolt holes (6 to 8 positions) on its flange. Too much gap on the outer ring or a smaller number of fastening bolts may deteriorate the roundness of the bearing ring. It is suggested by TPI that:

- Bearing bore $d \leq 100$ mm, the gap is 0.01-0.03mm ;
- Bearing bore $d \geq 100$ mm, the gap is 0.02-0.04mm ;

Table 8.1 Nut tightening force

Bearing bore mm	Nut tightening force N	Front cover drive-up mm
20-35	2940~4900	0.01~0.02
40-50	4900~9800	
55-75	9800~14700	
80-130	14700~24500	0.02~0.04
140-200	24500~34300	
220-300	34300~44100	

Fig. 8.4 Front cover pressing allowance or gap

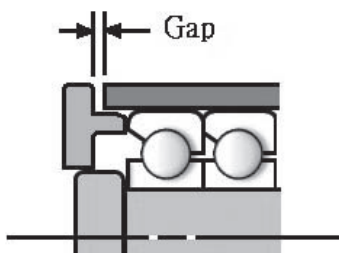

8.5 Starting Torque of BS Bearings

The BS type is mainly installed on ball screws of machine tool feed systems, and two to four row arrangements are used in many cases. This type is popular because greased sealed angular contact ball bearings are easy to handle. The starting torque can be altered depending on the bearing arrangement and preload. Reference starting torque values for BS bearings with normal preload are shown in Table 8.2.

Table 8.2 Starting torque of BS bearings with various arrangements

Bearing/Arrangement	Start torque(reference) N mm			
	DF DB	DFT DBT	DTFT DTBT	DFTT DBTT
BS1747	175	245	355	275
BS2047	175	245	355	275
BS2562	305	420	615	470
BS3062	305	420	615	470
BS3572	380	510	755	590
BS4072	380	510	755	590
BS4090	960	1305	1930	1500
BS4575	430	580	860	665
BS50100	1165	1580	2340	1815

8.6 Clearance Adjustment for Cylindrical Roller Bearing

For high rigidity main spindle applications such as an NC turning machine or machining center, a cylindrical roller with taper bore is usually used at the front side. The radial clearance or preload need to be adjusted accurately. The internal clearance is adjusted by fitting the tapered bore bearing onto the tapered portion of the main spindle and driving the bearing in the axial direction to expand the inner ring. For adjusting the internal clearance, two methods are available: a method consisting of clearance measurement for each bearing and adjustment with a spacer(s), and a method with an internal clearance adjustment gage or so-called GB gage.

8.6.1 Method with clearance measurement and adjustment with spacer (s)

(a) Calculation of outer ring shrinkage ΔG with the formula:

$$\Delta G = \Delta_{deff} \cdot \frac{D_0}{D} \cdot \frac{1 - (D/D_h)^2}{1 - (D_0/D)^2 \cdot (D/D_h)^2}$$

- where , ΔG :Outer ring shrinkage ,mm
- D_h : Housing bore diameter ,mm
- D : Bearing outer ring outside diameter ,mm
- D_0 : Bearing outer ring bore diameter ,mm
- Δ_{deff} : Interference at fitting area ,mm

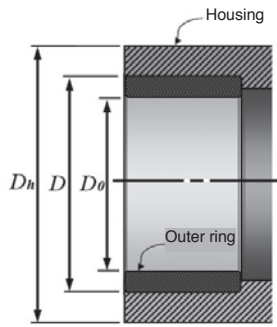

(b) Mount the bearing inner ring with the cage and rollers onto the tapered shaft shown in Fig. 8.5. Lightly coat the tapered bore with thin oil and position the inner ring on the shaft. It should make good contact with its seat and check that the bearing side face is square to the main spindle centerline. Calculate the estimated bearing clearance Δ_1 after press-fitting the outer ring into the housing with the following formula:

$$\Delta_1 = \Delta_{r1} - \Delta G$$

where , Δ_1 : Internal clearance after mounting , μm

Δ_{r1} : Estimated bearing clearance , μm

Fig.8.5 Measurement of bearing position and radial clearance

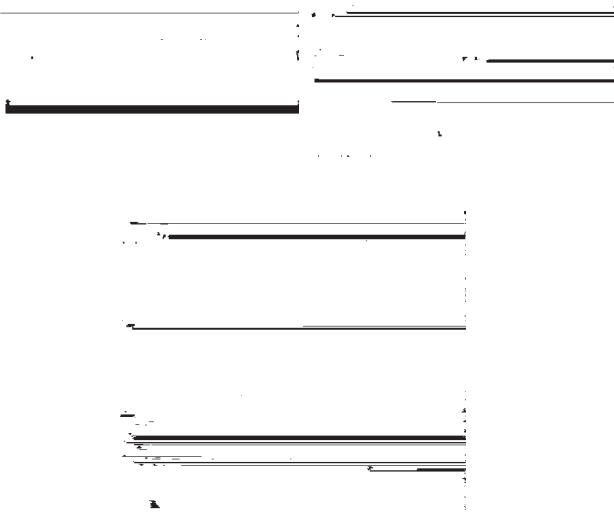

(c) To adjust the bearing clearance to a predetermined target value (δ) after mounting, determine the spacer width L_a as follows:

$$L_a = L_1 - K(\delta - \Delta_1)$$

where , L_1 : Distance between the shaft shoulder and inner ring side face mm

L_a : Spacer width mm, refer to Fig. 8.6

K : Coefficient refer to Table 8.3

Fig.8.6 Clearance measurement after insertion of spacer

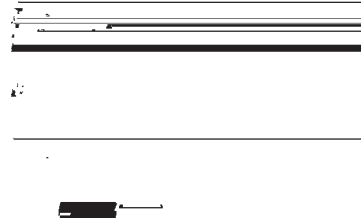

Table 8.3 Hollow shaft ratio and coefficient K

Hollow shaft ratio k	Coefficient K
0%~20%	13
20%~30%	14
30%~40%	15
40%~50%	16
50%~60%	17
60%~70%	18

Hollow shaft ratio $k = (d_m / d_i) \times 100\%$

(d) Insert a spacer that satisfies the spacer width L_a between the shoulder and inner ring determined in the previous step, and tighten the inner ring until the spacer does not move. Next, move the bearing outer ring up and down by hand and measure the internal clearance after mounting. Repeat the steps above to gradually decrease the spacer width so as to adjust the post-mounting bearing clearance to the targeted clearance. The spacer width for the final targeted clearance will be more readily obtained.

8.6.2 Method with internal clearance gage

When exact preload adjustment is critical for the application, mounting the cylindrical roller bearings with internal can be done with clearance adjustment gage. The gauge has a cylindrical ring, which has a cutout so that the ring can be opened and closed. The bore surface of the ring is used as a location for measurement to replace the outer ring raceway diameter measured after mounting with the bore gage to the mounted internal clearance adjustment gage.

The gauge generally has its adjustment screw with dial indicator for mounting and dismounting. Since it is not the real housing with outer ring in position, each gauge has its own correction factor and value provided. Be sure to follow the gauge instructions for use

Angular Contact Ball Bearings

BS Type

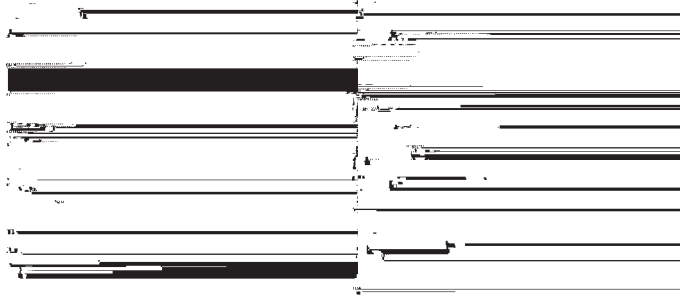

Open Type

Sealed Type

Table 1.1 Value of Factors X and Y

Normal Contact Angle	$f_0 F_a^* / C_{or}$	e	Single,DT				DB or DF					
			$F_a/F_r \leq e$		$F_a/F_r > e$		$F_a/F_r \leq e$		$F_a/F_r > e$			
			X	Y	X	Y	X	Y	X	Y		
15	0.178	0.38	1	0	0.44	1	1.47	1	0.72	1.65	0.72	2.39
	0.357	0.4					1.4			1.57		2.28
	0.714	0.43					1.3			1.46		2.11
	1.07	0.46					1.23			1.38		2
	1.43	0.47					1.19			0.34		1.93
	2.14	0.5					1.12			0.26		1.82
	3.57	0.55					1.02			1.14		1.66
	5.35	0.56					1			1.12		1.63
18	0.57	1	0	0.43	1	1	1.09	0.7	1.63			
25	0.68	1	0	0.41	0.87	1	0.92	1.67	1.41			
30	0.8	1	0	0.39	0.76	1	0.78	1.63	1.24			
40	1.14	1	0	0.35	0.57	1	0.55	0.57	0.93			
50	1.49			0.73	1	1.37	0.57	0.73				
55	1.79			0.81	1	1.6	0.56	0.81				
60	2.17			0.92	1	1.9	0.55	0.92				

For i, use 2 for DB,DF and 1 for DT

Boundary Dimensions (mm)					Basic Load Ratings				Static Axial Load Capacity		Bearing Numbers Type
d	D	B	$r_{s \min}$	$r_{1s \min}$	Dynamic		Static		(KN)	(Kgf)	
					C_a (KN)	C_a (Kgf)	C_{coa} (KN)	C_{coa} (Kgf)			
17	47	15	1	0.6	24.3	2470	37.5	3850	25.7	2620	BS1747 LLE* BS1747
20	47	15	1	0.6	24.3	2470	37.5	3850	25.7	2620	BS2047 LLE BS2047
25	62	15	1	0.6	29.2	2980	59.0	6050	40.0	4100	BS2562 LLE BS2562
30	62	15	1	0.6	29.2	2980	59.0	6050	40.0	4100	BS3062 LLE BS3062
35	72	15	1	0.6	31.0	3150	70.0	7150	47.5	4850	BS3572 LLE BS3572
40	72	15	1	0.6	31.0	3150	70.0	7150	47.5	4850	BS4072 LLE BS4072
40	90	20	1	0.6	58.5	6000	130	13300	88.5	9000	BS4090 LLE* BS4090
45	75	15	1	0.6	32.0	3300	77.5	7900	52.5	5350	BS4575 LLE* BS4575

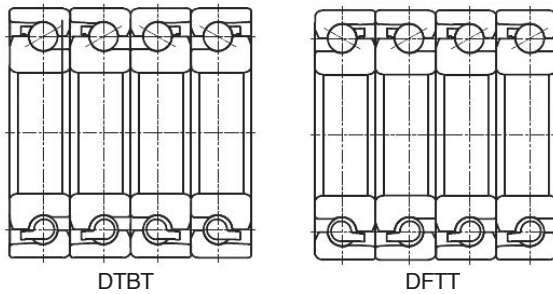
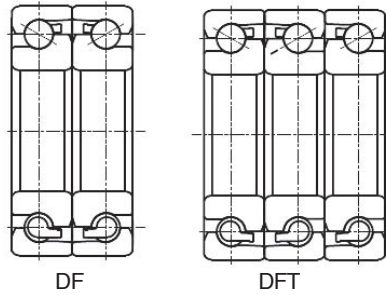

Table 2.1 Static Equivalent Load $P_o = X_o F_r + Y_o F_a$

Contact Angle	Single DT		DB or DF	
	X_o	Y_o	X_o	Y_o
15	0.5	0.46	1	0.92
18	0.5	0.42	1	0.84
25	0.5	0.38	1	0.76
30	0.5	0.33	1	0.66
40	0.5	0.26	1	0.52

where P_o : Static equivalent load(N)
 F_r : Radial load(N)
 F_a : Axial load(N)
 X_o : Static radial load factor
 Y_o : static axial load factor

Load Center (mm)	Limiting Speeds n_L (min^{-1})		Reference Dimensions				Space Capacity (cm^3)	Weight (kg)	Bearing Numbers Type
	Grease	Oil	d_1	d_2	D_1	D_2	Open (Approx)	Open (Approx)	
a									
36.5	10300	13700	30.6 33.4	24.2 27.1	20.6	22.9	3.3	0.129	BS1747 LLE* BS1747
36.5	10300	13700	30.6 33.4	24.2 27.1	78.1	83.4	3.3	0.118	BS2047 LLE BS2047
49.2	7200	9600	45.0 47.9	38.7 41.6	83.1	88.4	4.6	0.231	BS2562 LLE BS2562
49.2	7200	9600	45.0 47.9	38.7 41.6	88.1	93.4	4.6	0.205	BS3062 LLE BS3062
53.8	6500	8600	53.0 55.8	46.7 49.5	114.9	121.7	5.4	0.284	BS3572 LLE BS3572
56.0	6500	8600	53.0 55.8	46.7 49.5	123.2	130.8	5.4	0.250	BS4072 LLE BS4072
64.8	5100	6800	65.1 68.0	54.1 57.0	128.2	135.8	12	0.636	BS4090 LLE* BS4090
58.4	5500	7400	59.4 62.2	52.8 55.6	133.2	140.8	6.0	0.254	BS4575 LLE* BS4575

Angular Contact Ball Bearings

70C Series

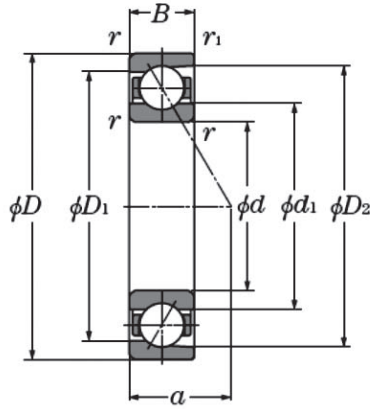

Table 1.1 Value of Factors X and Y

Normal Contact Angle	if $F_a^* \leq C_{or}$	e	Single,DT				DB or DF						
			$F_a/F_r \leq e$		$F_a/F_r > e$		$F_a/F_r \leq e$		$F_a/F_r > e$				
			X	Y	X	Y	X	Y	X	Y			
15	0.178	0.38	1	0	0.44	1	1	1.09	0.7	1.63	2.39		
	0.357	0.4										1.47	1.65
	0.714	0.43										1.4	1.57
	1.07	0.46										1.3	1.46
	1.43	0.47										1.23	1.38
	2.14	0.5										1.19	1.34
	3.57	0.55										1.12	1.26
	5.35	0.56										1.02	1.14
18	0.57	1	0	0.43	1	1	1.09	0.7	1.63	2.39			
25	0.68	1	0	0.41	0.87	1	0.92	1.67	1.41				
30	0.8	1	0	0.39	0.76	1	0.78	1.63	1.24				
40	1.14	1	0	0.35	0.57	1	0.55	0.57	0.93				
50	1.49			0.73	1	1.37	0.57	0.73					
55	1.79			0.81	1	1.6	0.56	0.81					
60	2.17			0.92	1	1.9	0.55	0.92					

For i, use 2 for DB,DF and 1 for DT

d 10~100mm

Boundary Dimensions (mm)					Basic Load Ratings				Static Axial Load Capacity		Bearing Numbers Type
d	D	B	$r_{s \min}$	$r_{1s \min}$	Dynamic		Static		(KN)	(Kgf)	
					C_r (KN)	C_r (Kgf)	C_{or} (KN)	C_{or} (Kgf)			
10	26	8	0.30	0.15	5.3	540	2.49	250	4.4	450	7000C
12	28	8	0.30	0.15	5.4	555	2.64	269	5.3	540	7001C
15	32	9	0.30	0.15	6.25	635	3.4	345	6.4	650	7002C
17	35	10	0.30	0.15	6.6	670	3.8	390	5.9	605	7003C
20	42	12	0.60	0.30	11.1	1130	6.55	670	10.2	1040	7004C
25	47	12	0.60	0.30	11.7	1190	7.45	755	11.2	1140	7005C
30	55	13	1.00	0.60	15.1	1540	10.3	1050	15.7	1600	7006C
35	62	14	1.00	0.60	19.1	1950	13.7	1400	20.6	2100	7007C
40	68	15	1.00	0.60	20.6	2100	15.9	1620	22.5	2300	7008C
45	75	16	1.00	0.60	24.4	2490	19.3	1970	27.9	2850	7009C
50	80	16	1.00	0.60	26.0	2650	21.9	2230	31.4	3200	7010C
55	90	18	1.10	0.60	34.0	3500	28.6	2900	40.7	4150	7011C
60	95	18	1.10	0.60	35.0	3600	30.5	3100	43.1	4400	7012C
65	100	18	1.10	0.60	37.0	3800	34.5	3500	47.5	4850	7013C
70	110	20	1.10	0.60	47.0	4800	43.0	4400	65.1	6640	7014C
75	115	20	1.10	0.60	48.0	4900	45.5	4650	65.7	6700	7015C
80	125	22	1.10	0.60	58.5	6000	55.5	5650	79.4	8100	7016C
85	130	22	1.10	0.60	60.0	6150	58.5	6000	83.3	8500	7017C
90	140	24	1.50	1.10	71.5	7300	69.0	7000	100.9	10300	7018C
95	145	24	1.50	1.10	73.5	7500	73.0	7450	102.9	10500	7019C
100	150	24	1.50	1.10	75.5	7700	77.0	7900	111.7	11400	7020C

① Minimum allowable dimension for chamfer dimension r or r₁

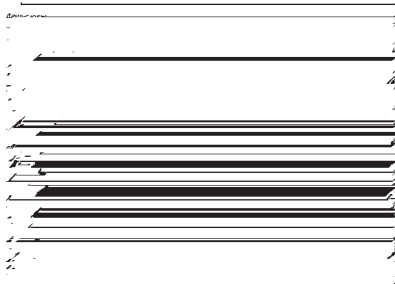

Back-to-back (DB)

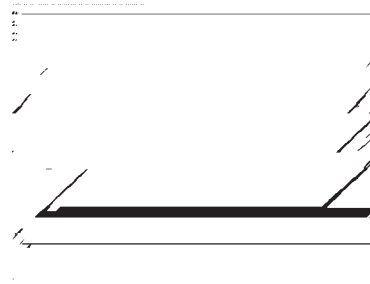

Face-to-face (DF)

Table 2.1 Static Equivalent Load $P_o = X_o F_r + Y_o F_a$

Contact Angle	Single DT		DB or DF	
	X_o	Y_o	X_o	Y_o
15	0.5	0.46	1	0.92
18	0.5	0.42	1	0.84
25	0.5	0.38	1	0.76
30	0.5	0.33	1	0.66
40	0.5	0.26	1	0.52

where P_o : Static equivalent load(N)
 F_r : Radial load(N)
 F_a : Axial load(N)
 X_o : Static radial load factor
 Y_o : static axial load factor

Load Center (mm)	Limiting Speeds n_L (min^{-1})		Reference Dimensions				Abutment and Dimensions (mm)					Space Capacity (cm^3)	Weight (kg)
	Grease	Oil	d_1	d_2	D_1	D_2	d_a min	D_a max	D_b max	r_{as} max	r_{las} max	Open (Approx)	Open (Approx)
6.0	63900	97300	15.4	—	20.6	22.9	12.5	23.5	24.8	0.3	0.15	0.96	0.019
6.5	57500	87500	18.1	—	22.6	25.4	14.5	25.5	26.8	0.3	0.15	1.04	0.021
7.5	49000	74500	21.1	—	26.1	28.5	17.5	29.5	30.8	0.3	0.15	1.33	0.030
8.5	44300	67400	23.4	—	28.6	31.0	19.5	32.5	33.8	0.3	0.15	1.78	0.039
10.0	37100	56500	27.5	—	34.5	37.7	25	37	39.5	0.6	0.3	3.26	0.067
11.0	32000	48700	32.5	—	39.5	42.7	29.5	42.5	44.5	0.6	0.3	3.85	0.078
12.0	27100	41200	38.6	—	46.4	50.0	36	49	50	1.0	0.5	5.11	0.114
13.5	23800	36100	44.2	—	52.8	56.9	41	56	57	1.0	0.5	7.26	0.151
15.0	21300	32500	49.6	—	58.3	62.4	45.5	62.5	63.5	1.0	0.6	8.89	0.189
16.0	19200	29200	55.2	—	64.8	69.2	51	69	70	1.0	0.5	11.11	0.238
16.0	17700	27000	60.2	—	69.8	74.2	55.5	74.5	75.5	1.0	0.6	11.85	0.259
19.0	15900	24200	66.8	—	78.1	83.4	62	83	85	1.0	0.6	17.78	0.380
19.5	14900	22600	71.8	—	83.1	88.4	67	88	90	1.0	0.6	19.26	0.405
20.0	14000	21300	76.8	—	88.1	93.4	72	93	95.5	1.0	0.6	21.23	0.435
22.0	12800	19500	83.6	—	96.4	102.5	77	103	105	1.0	0.6	26.67	0.606
23.0	12200	18500	88.5	—	101.5	107.5	82	108	110.5	1.0	0.6	27.54	0.643
25.0	11300	17100	95.1	—	109.9	116.7	87	118	120.5	1.0	0.6	37.78	0.855
25.0	10700	16300	100.1	—	114.9	121.7	92	123	125.5	1.0	0.6	39.26	0.898
27.0	10000	15300	106.8	—	123.2	130.8	99	131	134	1.5	0.8	48.89	1.160
28.0	9600	14600	111.7	—	128.2	135.8	103.5	136.5	139.5	1.5	1.0	50.37	1.210
29.0	9200	14000	116.8	—	133.2	140.8	108.5	141.5	144.5	1.5	1.0	53.33	1.270

Angular Contact Ball Bearings

70AD Series

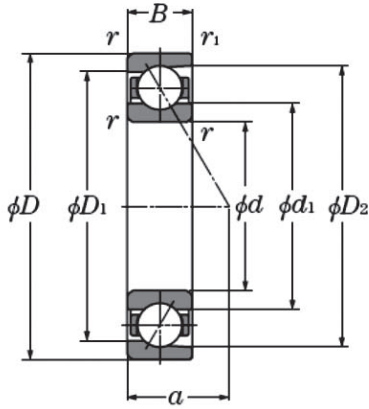

Table 1.1 Value of Factors X and Y

Normal Contact Angle	if ϕFa^* Cor	e	Single,DT				DB or DF									
			Fa/Fr ≤ e		Fa/Fr > e		Fa/Fr ≤ e		Fa/Fr > e							
			X	Y	X	Y	X	Y	X	Y						
15	0.178	0.38	1	0	0.44	1	1	1.47	1.65	0.72	2.39					
	0.357	0.4						1.4	1.57		2.28					
	0.714	0.43						1.3	1.46		2.11					
	1.07	0.46						1.23	1.38		2					
	1.43	0.47						1.19	0.34		1.93					
	2.14	0.5						1.12	0.26		1.82					
	3.57	0.55						1.02	1.14		1.66					
	5.35	0.56						1	1.12		1.63					
	18	0.57						1	0		0.43	1	1	1.09	0.7	1.63
	25	0.68						1	0		0.41	0.87	1	0.92	1.67	1.41
30	0.8	1	0	0.39	0.76	1	0.78	1.63	1.24							
40	1.14	1	0	0.35	0.57	1	0.55	0.57	0.93							
50	1.49			0.73	1	1.37	0.57	0.73								
55	1.79			0.81	1	1.6	0.56	0.81								
60	2.17			0.92	1	1.9	0.55	0.92								

For i, use 2 for DB,DF and 1 for DT

d 10~100mm

Boundary Dimensions (mm)					Basic Load Ratings				Static Axial Load Capacity		Bearing Numbers Type
d	D	B	r _{s min}	r _{1s min}	Dynamic		Static		(KN)	(Kgf)	
					C _r (KN)	C _r (Kgf)	C _{or} (KN)	C _{or} (Kgf)			
10	26	8	0.30	0.15	5.1	520	2.41	245	3.2	330	7000AD
12	28	8	0.30	0.15	5.2	530	2.53	260	4	410	7001AD
15	32	9	0.30	0.15	6.0	610	3.24	330	4.9	505	7002AD
17	35	10	0.30	0.15	6.3	640	3.65	370	4.4	450	7003AD
20	42	12	0.60	0.30	10.6	1080	6.27	640	7.5	770	7004AD
25	47	12	0.60	0.30	11.1	1100	7.1	720	8.3	850	7005AD
30	55	13	1.00	0.60	14.4	1470	9.8	1000	11.6	1180	7006AD
35	62	14	1.00	0.60	18.2	1860	13.1	1335	15.7	1600	7007AD
40	68	15	1.00	0.60	19.5	1990	15.1	1540	16.7	1700	7008AD
45	75	16	1.00	0.60	23.1	2360	18.3	1865	20.6	2100	7009AD
50	80	16	1.00	0.60	24.6	2510	20.8	2120	23	2350	7010AD
55	90	18	1.10	0.60	32.4	3300	27.2	2775	29.9	3050	7011AD
60	95	18	1.10	0.60	33.2	3390	29	2960	31.8	3240	7012AD
65	100	18	1.10	0.60	35.1	3580	32.5	3315	34.8	3550	7013AD
70	110	20	1.10	0.60	44.4	4530	40.9	4170	48.5	4950	7014AD
75	115	20	1.10	0.60	45.4	4630	43.2	4405	48.6	4960	7015AD
80	125	22	1.10	0.60	55.6	5670	52.5	5360	58.3	5950	7016AD
85	130	22	1.10	0.60	56.9	5810	53.5	5460	61.3	6250	7017AD
90	140	24	1.50	1.10	67.8	6920	65.5	6680	75	7650	7018AD
95	145	24	1.50	1.10	69.5	7090	69.4	7080	76	7750	7019AD
100	150	24	1.50	1.10	71.2	7260	73.1	7460	82.8	8450	7020AD

① Minimum allowable dimension for chamfer dimension r or r₁

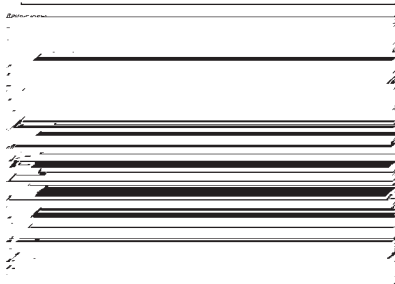

Back-to-back
(DB)

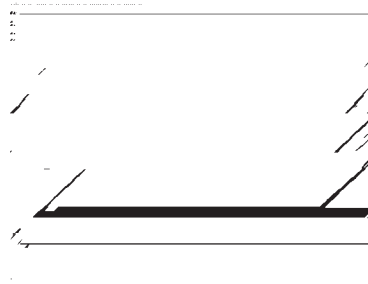

Face-to-face
(DF)

Table 2.1 Static Equivalent Load $P_o = X_o F_r + Y_o F_a$

Contact Angle	Single DT		DB or DF	
	X_o	Y_o	X_o	Y_o
15	0.5	0.46	1	0.92
18	0.5	0.42	1	0.84
25	0.5	0.38	1	0.76
30	0.5	0.33	1	0.66
40	0.5	0.26	1	0.52

where P_o : Static equivalent load(N)
 F_r : Radial load(N)
 F_a : Axial load(N)
 X_o : Static radial load factor
 Y_o : static axial load factor

Load Center (mm)	Limiting Speeds n_L (min^{-1})		Reference Dimensions				Abutment and Dimensions (mm)					Space Capacity (cm^3)	Weight (kg)
	a	Grease	Oil	d_1	d_2	D1	D2	d_a min	D_a max	D_b max	r_{as} max	r_{las} max	Open (Approx)
8	57500	87600	15.4	—	20.6	22.9	12.5	23.5	24.8	0.3	0.15	0.96	0.019
8.5	51800	78800	18.1	—	22.6	25.4	14.5	25.5	26.8	0.3	0.15	1.04	0.021
9.5	44100	67100	21.1	—	26.1	28.5	17.5	29.5	30.8	0.3	0.15	1.33	0.030
10.5	39900	60700	23.4	—	28.6	31.0	19.5	32.5	33.8	0.3	0.15	1.78	0.039
12.5	33400	50900	27.5	—	34.5	37.7	25	37	39.5	0.6	0.3	3.26	0.067
13.5	28800	43800	32.5	—	39.5	42.7	29.5	42.5	44.5	0.6	0.3	3.85	0.078
15.5	24400	37100	38.6	—	46.4	50.0	36	49	50	1.0	0.5	5.11	0.114
17	21400	32500	44.2	—	52.8	56.9	41	56	57	1.0	0.5	7.26	0.151
19	19200	29300	49.6	—	58.3	62.4	45.5	62.5	63.5	1.0	0.6	8.89	0.189
21	17300	26300	55.2	—	64.8	69.2	51	69	70	1.0	0.5	11.11	0.238
22	15900	24300	60.2	—	69.8	74.2	55.5	74.5	75.5	1.0	0.6	11.85	0.259
24	14300	21800	66.8	—	78.1	83.4	62	83	85	1.0	0.6	17.78	0.380
25	13400	20300	71.8	—	83.1	88.4	67	88	90	1.0	0.6	19.26	0.405
26.5	12600	19200	76.8	—	88.1	93.4	72	93	95.5	1.0	0.6	21.23	0.435
29	11500	17600	83.6	—	96.4	102.5	77	103	105	1.0	0.6	26.67	0.606
30	11000	16700	88.5	—	101.5	107.5	82	108	110.5	1.0	0.6	27.54	0.643
32.5	10200	15400	95.1	—	109.9	116.7	87	118	120.5	1.0	0.6	37.78	0.855
34	9600	14700	100.1	—	114.9	121.7	92	123	125.5	1.0	0.6	39.26	0.898
36	9000	13800	106.8	—	123.2	130.8	99	131	134	1.5	0.8	48.89	1.160
37	8600	13100	111.7	—	128.2	135.8	103.5	136.5	139.5	1.5	1.0	50.37	1.210
38	8300	12600	116.8	—	133.2	140.8	108.5	141.5	144.5	1.5	1.0	53.33	1.270

Angular Contact Ball Bearings

70 A Series

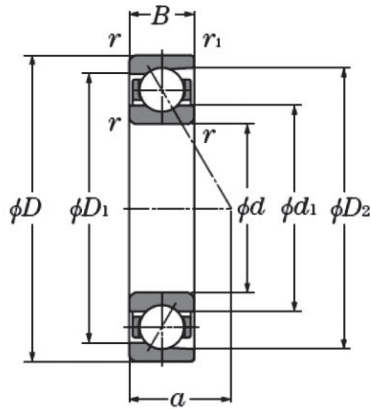

Table 1.1 Value of Factors X and Y

Normal Contact Angle	$\frac{f_0 F_a^*}{C_{or}}$	e	Single,DT				DB or DF				
			$F_a/F_r \leq e$		$F_a/F_r > e$		$F_a/F_r \leq e$		$F_a/F_r > e$		
			X	Y	X	Y	X	Y	X	Y	
15	0.178	0.38	1	0	0.44	1	1	1.47	1.65	0.72	2.39
	0.357	0.4						1.4	1.57		2.28
	0.714	0.43						1.3	1.46		2.11
	1.07	0.46						1.23	1.38		2
	1.43	0.47						1.19	0.34		1.93
	2.14	0.5						1.12	0.26		1.82
	3.57	0.55						1.02	1.14		1.66
	5.35	0.56						1	1.12		1.63
18	0.57	1	0	0.43	1	1	1.09	0.7	1.63		
25	0.68	1	0	0.41	0.87	1	0.92	1.67	1.41		
30	0.8	1	0	0.39	0.76	1	0.78	1.63	1.24		
40	1.14	1	0	0.35	0.57	1	0.55	0.57	0.93		
50	1.49			0.73	1	1.37	0.57	0.73			
55	1.79			0.81	1	1.6	0.56	0.81			
60	2.17			0.92	1	1.9	0.55	0.92			

For i, use 2 for DB,DF and 1 for DT

d 10~100mm

Boundary Dimensions (mm)					Basic Load Ratings				Static Axial Load Capacity		Bearing Numbers Type
d	D	B	$r_{s \min}$	$r_{1s \min}$	Dynamic		Static		(KN)	(Kgf)	
					C_r (KN)	C_r (Kgf)	C_{or} (KN)	C_{or} (Kgf)			
10	26	8	0.3	0.15	5	510	2.33	238	2.0	204	7000A
12	28	8	0.3	0.15	5.05	515	2.46	251	2.38	243	7001A
15	32	9	0.3	0.15	5.8	590	3.15	320	2.9	296	7002A
17	35	10	0.3	0.15	6.09	620	3.52	360	3.43	350	7003A
20	42	12	0.6	0.3	10.3	1050	6.07	620	5.8	591	7004A
25	47	12	0.6	0.3	10.8	1100	6.21	630	6.38	650	7005A
30	55	13	1	0.6	13.9	1420	9.46	960	9.03	920	7006A
35	62	14	1	0.6	17.5	1780	12.6	1280	11.0	1120	7007A
40	68	15	1	0.6	18.2	1855	14.3	1457	12.8	1306	7008A
45	75	16	1	0.6	22.5	2290	17.6	1900	15.7	1600	7009A
50	80	16	1	0.6	23.7	2410	20	2040	17.9	1820	7010A

① Minimum allowable dimension for chamfer dimension r or r_1

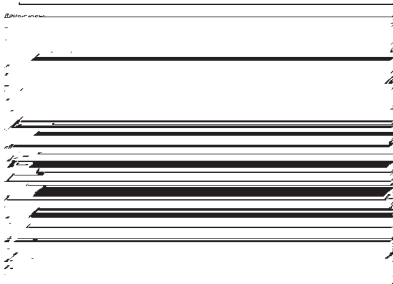

Back-to-back (DB)

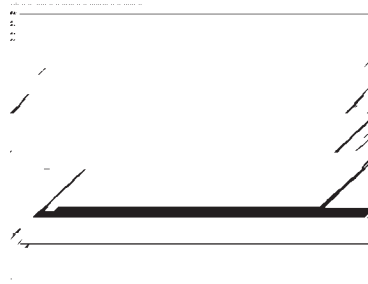

Face-to-face (DF)

Table 2.1 Static Equivalent Load $P_o = X_o F_r + Y_o F_a$

Contact Angle	Single DT		DB or DF	
	X_o	Y_o	X_o	Y_o
15	0.5	0.46	1	0.92
18	0.5	0.42	1	0.84
25	0.5	0.38	1	0.76
30	0.5	0.33	1	0.66
40	0.5	0.26	1	0.52

where P_o : Static equivalent load(N)
 F_r : Radial load(N)
 F_a : Axial load(N)
 X_o : Static radial load factor
 Y_o : static axial load factor

Load Center (mm)	Limiting Speeds n_L (min^{-1})		Reference Dimensions				Abutment and Dimensions (mm)					Space Capacity (cm^3)	Weight (kg)
	Grease	Oil	d_1	d_2	D_1	D_2	d_a min	D_a max	D_b max	r_{as} max	r_{las} max	Open (Approx)	Open (Approx)
9.2	46600	60300	15.4	—	20.3	22.7	12.5	23.5	24.8	0.3	0.15	0.9	0.021
10	41900	54200	18.1	—	22.9	25.4	14.5	25.5	26.8	0.3	0.15	1.04	0.025
11.5	35700	46100	21.1	—	25.9	28.4	17.5	29.5	30.8	0.3	0.15	1.33	0.03
16	32300	41800	23.4	—	28.6	31	19.5	32.5	33.8	0.3	0.15	1.78	0.039
14.9	27000	35000	27.5	—	34.5	37.2	24.5	37.5	39.5	0.6	0.3	2.9	0.067
16.4	23300	30200	32.5	—	39.5	42.2	29.5	42.5	44.5	0.6	0.3	3.3	0.079
18.8	19800	25500	38.6	—	46.4	49.5	35.5	49.5	50.5	1	0.6	4.8	0.11
21.0	17400	22400	44.2	—	52.8	56.3	40.5	56.5	57.5	1	0.6	6.3	0.15
23.1	15500	20100	49.6	—	58.3	61.8	45.5	62.5	63.5	1	0.6	8.89	0.189
25.8	14000	18100	55.2	—	64.8	68.6	50.5	69.5	70.5	1	0.6	9.4	0.24
28.2	12900	16700	60.2	—	69.8	73.6	55.5	74.5	75.5	1	0.6	11	0.26

Angular Contact Ball Bearings

HS CE1 Series

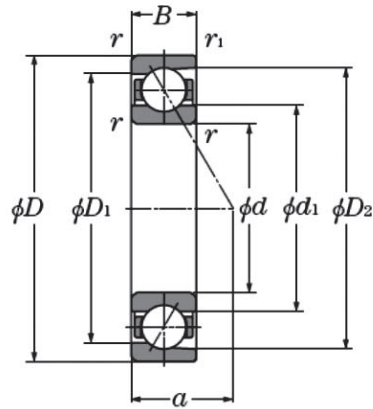

Table 1.1 Value of Factors X and Y

Normal Contact Angle	if $F_a^* \leq C_{or}$	e	Single,DT				DB or DF				
			$F_a/F_r \leq e$		$F_a/F_r > e$		$F_a/F_r \leq e$		$F_a/F_r > e$		
			X	Y	X	Y	X	Y	X	Y	
15	0.178	0.38	1	0	0.44	1	1.47	1	1.65	0.72	2.39
	0.357	0.4					1.4		1.57		2.28
	0.714	0.43					1.3		1.46		2.11
	1.07	0.46					1.23		1.38		2
	1.43	0.47					1.19		0.34		1.93
	2.14	0.5					1.12		0.26		1.82
	3.57	0.55					1.02		1.14		1.66
	5.35	0.56					1		1.12		1.63
18	0.57	1	0	0.43	1	1	1.09	0.7	1.63		
25	0.68	1	0	0.41	0.87	1	0.92	1.67	1.41		
30	0.8	1	0	0.39	0.76	1	0.78	1.63	1.24		
40	1.14	1	0	0.35	0.57	1	0.55	0.57	0.93		
50	1.49			0.73	1	1.37	0.57	0.73			
55	1.79			0.81	1	1.6	0.56	0.81			
60	2.17			0.92	1	1.9	0.55	0.92			

For i, use 2 for DB,DF and 1 for DT

d 10~100mm

Boundary Dimensions (mm)					Basic Load Ratings				Static Axial Load Capacity		Bearing Numbers Type
d	D	B	r _{s min} ^①	r _{1s min} ^①	Dynamic		Static		(KN)	(Kgf)	
					C _r (KN)	C _r (Kgf)	C _{or} (KN)	C _{or} (Kgf)			
10	26	8	0.30	0.15	2.08	212	1.57	160	2.0	204	HS000CE1
12	28	8	0.30	0.15	2.06	210	1.6	163	2.1	210	HS001CE1
15	32	9	0.30	0.15	2.85	291	2.4	245	3.1	315	HS002CE1
17	35	10	0.30	0.15	2.92	298	2.6	265	3.3	340	HS003CE1
20	42	12	0.60	0.30	4.74	480	4.5	460	5.8	590	HS004CE1
25	47	12	0.60	0.30	4.77	490	4.9	500	6.3	640	HS005CE1
30	55	13	1.00	0.60	10.5	1070	10.0	1020	12.8	1310	HS006CE1
35	62	14	1.00	0.60	12.9	1320	12.7	1300	16.3	1660	HS007CE1
40	68	15	1.00	0.60	13.7	1400	14.5	1480	18.6	1900	HS008CE1
45	75	16	1.00	0.60	14.4	1470	16.3	1660	20.9	2130	HS009CE1
50	80	16	1.00	0.60	17.5	1790	20.1	2050	25.8	2630	HS010CE1
55	90	18	1.10	0.60	18.7	1910	23.4	2490	30.4	3100	HS011CE1
60	95	18	1.10	0.60	19.0	1940	24.6	2510	31.4	3200	HS012CE1
65	100	18	1.10	0.60	22.7	2320	29.7	3000	38	3900	HS013CE1
70	110	20	1.10	0.60	26.5	2700	35.3	3600	45	4600	HS014CE1
75	115	20	1.10	0.60	26.9	2750	36.9	3750	48	4900	HS015CE1
80	125	22	1.10	0.60	35.2	3600	47.9	4850	62	6300	HS016CE1
85	130	22	1.10	0.60	35.8	3650	50.1	5100	65	6600	HS017CE1
90	140	24	1.50	1.10	37.0	3800	54.2	5500	70	7150	HS018CE1
95	145	24	1.50	1.10	45.7	4700	65.3	6650	840	8550	HS019CE1
100	150	24	1.50	1.10	46.5	4750	68.1	6950	880	8950	HS020CE1

① Minimum allowable dimension for chamfer dimension r or r₁

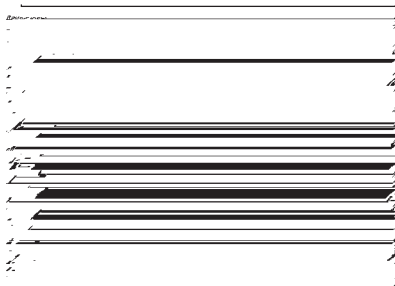

Back-to-back (DB)

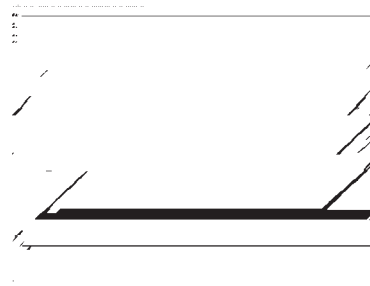

Face-to-face (DF)

Table 2.1 Static Equivalent Load $P_o = X_o F_r + Y_o F_a$

Contact Angle	Single DT		DB or DF	
	X_o	Y_o	X_o	Y_o
15	0.5	0.46	1	0.92
18	0.5	0.42	1	0.84
25	0.5	0.38	1	0.76
30	0.5	0.33	1	0.66
40	0.5	0.26	1	0.52

where P_o : Static equivalent load(N)
 F_r : Radial load(N)
 F_a : Axial load(N)
 X_o : Static radial load factor
 Y_o : static axial load factor

Load Center (mm)	Limiting Speeds n_L (min^{-1})		Reference Dimensions				Abutment and Dimensions (mm)					Space Capacity (cm^3)	Weight (kg)
	Grease	Oil	d_1	d_2	D_1	D_2	d_a min	D_a max	D_b max	r_{as} max	r_{las} max	Open (Approx)	Open (Approx)
7.0	77900	119800	16.3	13.4	19.8	22.5	14	12	12.6	0.3	0.15	0.59	0.019
7.2	65900	101400	18.3	15.0	21.8	24.9	16.5	24.5	25.1	0.3	0.15	0.67	0.021
8.0	53900	82900	21.6	18.5	25.6	28.5	19	29	30.5	0.3	0.15	0.96	0.028
9.0	47900	73700	24.1	20.2	28.1	31.8	21	32	32.6	0.3	0.15	1.33	0.035
11.0	40100	61700	28.6	24.3	33.6	37.7	25	37	38.2	0.6	0.3	2.22	0.065
12.0	33500	51600	33.6	29.3	38.6	42.7	30	42	43.2	0.6	0.3	2.52	0.078
13.0	35900	55300	38.7	35.7	46.3	49.2	34.6	50.4	52.4	1.0	0.6	3.93	0.110
15.0	29900	46100	44.2	40.9	52.8	56.0	39.6	57.4	59.4	1.0	0.6	4.89	0.150
16.0	27000	41500	49.7	46.4	58.2	61.6	44.6	63.4	65.4	1.0	0.6	5.93	0.190
18.0	24600	37800	55.7	52.2	64.2	67.6	49.6	70.4	72.4	1.0	0.6	8.15	0.240
19.0	22800	35000	60.2	56.6	69.8	73.4	54.6	75.4	77.4	1.0	0.6	8.89	0.250
21.0	19200	29500	67.7	63.9	77.3	81.0	61	84	86.2	1.1	0.6	12.59	0.400
21.5	18000	27600	72.7	68.9	82.3	86.0	66	89	91.2	1.1	0.6	13.33	0.420
22.5	16800	25800	77.3	73.2	87.7	91.8	71	94	96.2	1.1	0.6	14.07	0.450
24.5	15600	24000	84.3	79.8	95.3	100.1	76	104	106.2	1.1	0.6	20.00	0.640
25.5	14400	22100	89.3	84.8	100.7	105.1	81	109	111.2	1.1	0.6	20.74	0.670
28.0	12900	19900	95.8	90.7	109.2	114.3	86	119	121.2	1.1	0.6	27.41	0.850
28.5	12600	19400	100.8	95.7	114.2	119.3	91	124	126.2	1.1	0.6	28.89	0.900
31.0	11600	17900	108.3	103.0	121.7	126.9	97	113	116	1.5	1.1	37.04	1.200
31.5	11100	17100	112.4	106.6	127.6	133.4	102	138	141	1.5	1.1	38.52	1.250
32.0	10700	16500	117.4	111.6	132.6	138.4	107	143	146	1.5	1.1	40.00	1.300

Angular Contact Ball Bearings

72C Series

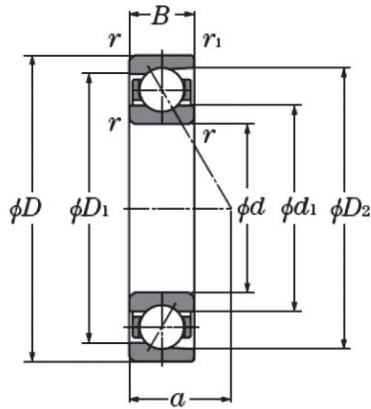

Table 1.1 Value of Factors X and Y

Normal Contact Angle	if $F_a \leq C_{or}$	e	Single,DT				DB or DF												
			$F_a/F_r \leq e$		$F_a/F_r > e$		$F_a/F_r \leq e$		$F_a/F_r > e$										
			X	Y	X	Y	X	Y	X	Y									
15	0.178	0.38	1	0	0.44	1	1	1.47	1	1.65	0.72	2.39							
	0.357	0.4						1.4					1.57						
	0.714	0.43						1.3					1.46						
	1.07	0.46						1.23					1.38						
	1.43	0.47						1.19					1.3						
	2.14	0.5						1.12					1.26						
	3.57	0.55						1.02					1.14						
	5.35	0.56						1					1.12						
	18	0.57						1					0	0.43	1	1	1.09	0.7	1.63
	25	0.68						1					0	0.41	0.87	1	0.92	1.67	1.41
30	0.8	1	0	0.39	0.76	1	0.78	1.63	1.24										
40	1.14	1	0	0.35	0.57	1	0.55	0.57	0.93										
50	1.49			0.73	1	1.37	0.57	0.73											
55	1.79			0.81	1	1.6	0.56	0.81											
60	2.17			0.92	1	1.9	0.55	0.92											

For i, use 2 for DB,DF and 1 for DT

d 10~100mm

Boundary Dimensions (mm)					Basic Load Ratings				Static Axial Load Capacity		Bearing Numbers Type
d	D	B	r _{s min} ^①	r _{1s min} ^①	Dynamic		Static		(KN)	(Kgf)	
					C _r (KN)	C _r (Kgf)	C _{or} (KN)	C _{or} (Kgf)			
10	30	9	0.6	0.3	5.40	555	2.64	269	1.01	103	7200C
12	32	10	0.6	0.3	7.10	720	3.45	355	1.59	162	7201C
15	35	11	0.6	0.3	9.00	915	4.50	460	1.89	193	7202C
17	40	12	0.6	0.3	11.2	1140	5.75	590	2.67	272	7203C
20	47	14	1.0	0.6	14.6	1490	8.15	835	3.70	375	7204C
25	52	15	1.0	0.6	16.6	1690	10.2	1050	3.75	385	7205C
30	62	16	1.0	0.6	23.0	2350	14.7	1500	7.10	725	7206C
35	72	17	1.1	0.6	30.5	3100	19.9	2030	10.6	1090	7207C
40	80	18	1.1	0.6	36.5	3700	25.2	2570	14.4	1470	7208C
45	85	19	1.1	0.6	41.0	4150	28.8	2940	14.8	1510	7209C
50	90	20	1.1	0.6	43.0	4350	31.5	3250	15.3	1560	7210C
55	100	21	1.5	1.0	53.0	5400	40.0	4100	21.6	2200	7211C
60	110	22	1.5	1.0	64.0	6550	49.5	5050	26.1	2660	7212C
65	120	23	1.5	1.0	70.0	7100	55.0	5600	28.5	2910	7213C
70	125	24	1.5	1.0	76.0	7750	60.0	6150	31.0	3150	7214C
75	130	25	1.5	1.0	79.5	8100	65.5	6700	33.5	3400	7215C
80	140	26	2.0	1.0	93.0	9450	77.5	7900	34.5	3550	7216C
85	150	28	2.0	1.0	104	10600	90.5	9200	46.5	4750	7217C
90	160	30	2.0	1.0	123	12500	105	10700	53.5	5450	7218C
95	170	32	2.1	1.1	139	14200	120	12200	62.0	6350	7219C
100	180	34	2.1	1.1	149	15200	127	12900	67.0	6800	7220C

① Minimum allowable dimension for chamfer dimension r or r₁

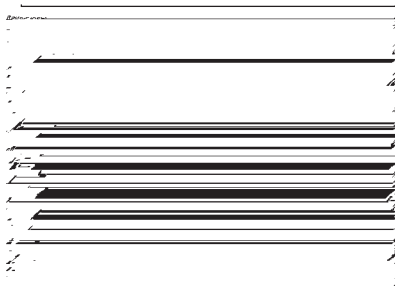

**Back-to-back
(DB)**

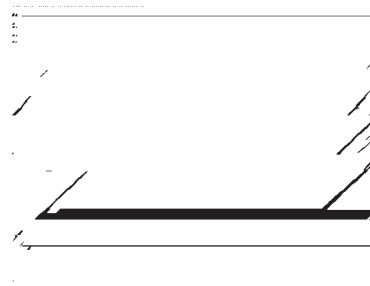

**Face-to-face
(DF)**

Table 2.1 Static Equivalent Load $P_o = X_o F_r + Y_o F_a$

Contact Angle	Single DT		DB or DF	
	Xo	Yo	Xo	Yo
15	0.5	0.46	1	0.92
18	0.5	0.42	1	0.84
25	0.5	0.38	1	0.76
30	0.5	0.33	1	0.66
40	0.5	0.26	1	0.52

where P_o : Static equivalent load(N)
 F_r : Radial load(N)
 F_a : Axial load(N)
 X_o : Static radial load factor
 Y_o : static axial load factor

Load Center (mm)	Limiting Speeds n_L (min^{-1})		Reference Dimensions				Abutment and Dimensions (mm)					Space Capacity (cm^3)	Weight (kg)
	Grease	Oil	d_1	d_2	D_1	D_2	d_a min	D_a max	D_b max	r_{as} max	r_{ias} max	Open (Approx)	Open (Approx)
7.0	42900	55600	17.4	—	23.0	26.2	14.5	25.5	27.5	0.6	0.3	0.9	0.029
8.0	40000	51800	18.7	—	25.7	28.2	16.5	27.5	29.5	0.6	0.3	1.3	0.036
9.0	35200	45600	21.7	—	28.7	31.3	19.5	30.5	32.5	0.6	0.3	1.5	0.045
10.0	30500	39600	24.8	—	32.7	35.7	21.5	35.5	37.5	0.6	0.3	2.1	0.062
11.5	25500	33000	29.2	—	38.5	41.9	25.5	41.5	42.5	1.0	0.6	3.1	0.1
13.0	22600	29200	34.2	—	43.5	47.0	30.5	46.5	47.5	1.0	0.6	4.1	0.12
14.0	18900	24500	40.8	—	52.0	56.0	35.5	56.5	57.5	1.0	0.6	6.6	0.19
16.0	16400	21300	47.4	—	60.5	65.2	42	65	67.5	1.0	0.6	8.8	0.27
17.0	14700	19000	53.5	—	67.5	72.4	47	73	75.5	1.0	0.6	11	0.35
18.0	13500	17500	58.1	—	73.0	78.4	52	78	80.5	1.0	0.6	14	0.40
19.0	12600	16300	63.1	—	78.0	82.5	57	83	85.5	1.0	0.6	17	0.45
21.0	11400	14700	69.7	—	86.5	91.5	63.5	91.5	94.5	1.5	1.0	21	0.59
22.0	10200	13200	76.3	—	95.0	100.5	68.5	101.5	104.5	1.5	1.0	28	0.76
24.0	9500	12300	83.4	—	103.0	109.5	73.5	111.5	114.5	1.5	1.0	34	0.95
25.0	9000	11700	87.9	—	108.5	114.5	78.5	116.5	119.5	1.5	1.0	40	1.04
26.0	8500	11000	92.9	—	113.5	119.6	83.5	121.5	124.5	1.5	1.0	43	1.14
28.0	8000	10400	99.6	—	121.9	128.6	90	130	134.5	2.0	1.0	54	1.39
30.0	7500	9700	106.2	—	130.5	137.7	95	140	144.5	2.0	1.0	63	1.73
32.0	7000	9100	112.9	—	138.9	146.7	100	150	154.5	2.0	1.0	80	2.13
34.0	6600	8600	119.5	—	147.4	155.8	107	158	163	2.0	1.0	96	2.58
36.0	6300	8100	126.2	—	155.9	164.8	112	168	173	2.0	1.0	119	3.21

Appendix I: Required Information for Spindle Bearings Selection

(1) Machine Type	<input type="checkbox"/> NC Lathe <input type="checkbox"/> Machine center <input type="checkbox"/> Grinding Machine <input type="checkbox"/> Others_____
(2) Main spindle orientation	<input type="checkbox"/> Vertical <input type="checkbox"/> Horizontal <input type="checkbox"/> Variable-direction <input type="checkbox"/> Inclined <input type="checkbox"/> Others_____
(3) Diameter of main spindle	<input type="checkbox"/> #30 <input type="checkbox"/> #40 <input type="checkbox"/> #50 <input type="checkbox"/> Others_____
(4) Shape and mounting-related dimension of main spindle	
(5) Intended bearing type, dimension and preload method	Front: <input type="checkbox"/> Cylindrical roller type <input type="checkbox"/> Angular contact type [^{**} <input type="checkbox"/> sealing] Rear: <input type="checkbox"/> Cylindrical roller type <input type="checkbox"/> Angular contact type [^{**} <input type="checkbox"/> sealing] Preloading system: <input type="checkbox"/> Fixed-position <input type="checkbox"/> Fixed-pressure
(6) Slide system free side	<input type="checkbox"/> Cylindrical roller bearing <input type="checkbox"/> Ball bushing (availability of cooling)
(7) Lubrication method	<input type="checkbox"/> Grease <input type="checkbox"/> Air-oil <input type="checkbox"/> Oil mist
(8) Drive system	<input type="checkbox"/> built-in motor <input type="checkbox"/> Belt drive <input type="checkbox"/> Coupling
(9) Presence/absence of jacket cooling arrangement on bearings area	<input type="checkbox"/> YES <input type="checkbox"/> NO
(10) Load conditions (machining conditions)	Max. speed:_____ Min-1 Radial load Fr:_____ N Axial load Fa:_____ N Moment:_____ N-mm Tightening force:_____ N
(11) Shaft and Housing	Shaft material:_____ Shaft tolerance:_____mm Housing material:_____ Housing tolerance:_____mm Housing outer diameter:_____ mm Hollow shaft bore diameter:_____ mm Fits on shaft :_____mm Fits on housing :_____mm Spacer length:_____mm Ambient temperature:_____°C
(12) Requirement Value	Rigidity: _____ N/um Preload: _____ N Life: _____ hours
(13) Specific Request	

Appendix II: Required Information for Ball Screw Support Bearings Selection

(1) Ball Screw Support Type	<input type="checkbox"/> Two-ends support <input type="checkbox"/> One-end support <input type="checkbox"/> Pretension
(2) Ball Screw Support Bearing	Installation type: <input type="checkbox"/> Fixed-Support <input type="checkbox"/> Fixed-Free <input type="checkbox"/> Fixed-Fixed Fixed-end bearing: <input type="checkbox"/> ACBB Support-end bearing: <input type="checkbox"/> ACBB <input type="checkbox"/> DGBB <input type="checkbox"/> NRB Fixed-end arrangement: <input type="checkbox"/> DB/DF <input type="checkbox"/> DBT/DFT <input type="checkbox"/> DTBT/DTFT Support-end arrangement: <input type="checkbox"/> Single <input type="checkbox"/> DB/DF <input type="checkbox"/> Others
(3) Lubrication method	<input type="checkbox"/> Grease <input type="checkbox"/> Air-oil
(4) Load conditions (machining conditions)	Max. speed: _____ Min-1 Radial load Fr: _____ N Axial load Fa _____ N Moment: _____ N-mm Tightening force: _____ N
(5) Shaft and Housing	Shaft material: _____ Shaft tolerance: _____mm Housing material: _____ Housing tolerance: _____mm Housing outer diameter: _____mm Hollow shaft bore diameter: _____mm Fits on shaft : _____mm Fits on housing : _____mm Spacer length: _____mm Ambient temperature: _____°C
(6) Requirement Value	Rigidity: _____ N/um Preload: _____ N Starting Torque: _____ N-mm Life: _____ hours
(7) Specific Requests	

Appendix III : Tolerance for Rolling Bearings

1.Radial Bearing(Angular Contact Ball Bearings)

Inner rings

Unit : μm

Nominal bore diameter		Single plane mean bore diameter deviation						Single radial plane bore diameter variation						Mean bore diameter deviation			Inner ring radial runout		
d		Δ_{dmp}						V_{dp}						V_{dmp}			K_{ia}		
mm		Class 5		Class 4 ^①		Class 2 ^①		Diameter series 9			Diameter series 0.2			Class 5 Class 4 Class 2			Class 5 Class 4 Class 2		
over	incl.	high	low	high	low	high	low	Class 5 max	Class 4	Class 2	Class 5 max	Class 4	Class 2	Class 5 max	Class 4	Class 2	Class 5 max	Class 4	Class 2
2.5	10	0	-5	0	-4	0	-2.5	5	4	2.5	4	3	2.5	3	2	1.5	4	2.5	1.5
10	18	0	-5	0	-4	0	-2.5	5	4	2.5	4	3	2.5	3	2	1.5	4	2.5	1.5
18	30	0	-6	0	-5	0	-2.5	6	5	2.5	5	4	2.5	3	2.5	1.5	4	3	2.5
30	50	0	-8	0	-6	0	-2.5	8	6	2.5	6	5	2.5	4	3	1.5	5	4	2.5
50	80	0	-9	0	-7	0	-4	9	7	4	7	5	4	5	3.5	2	5	4	2.5
80	120	0	-10	0	-8	0	-5	10	8	5	8	6	5	5	4	2.5	6	5	2.5
120	150	0	-13	0	-10	0	-7	13	10	7	10	8	7	7	5	3.5	8	6	2.5
150	180	0	-13	0	-10	0	-7	13	10	7	10	8	7	7	5	3.5	8	6	5
180	250	0	-15	0	-12	0	-8	15	12	8	12	9	8	8	6	4	10	8	5

① The tolerance of bore diameter deviation Δds , applicable to classes 4 and 2, is the same as the tolerance of mean bore diameter deviation Δdmp . This applies to the diameter series 0 or 2 for class 4, and all the diameter series for class 2.

② Applicable to individual bearing rings manufactured for duplex bearings.

Outer rings

Unit : μm

Nominal outside diameter		Single plane mean outside diameter deviation						Single radial plane outside diameter variation						Mean single plane outside diameter variation			Outer ring radial runout		
D		Δ_{Dmp}						V_{Dp}						V_{Dmp}			K_{eo}		
mm		Class 5		Class 4 ^③		Class 2 ^③		Diameter series 9			Diameter series 0.2			Class 5 Class 4 Class 2			Class 5 Class 4 Class 2		
over	incl.	high	low	high	low	high	low	Class 5 max	Class 4	Class 2	Class 5 max	Class 4	Class 2	Class 5 max	Class 4	Class 2	Class 5 max	Class 4	Class 2
18	30	0	-6	0	-5	0	-4	6	5	4	5	4	4	3	2.5	2	6	4	2.5
30	50	0	-7	0	-6	0	-4	7	6	4	5	5	4	4	3	2	7	5	2.5
50	80	0	-9	0	-7	0	-4	9	7	4	7	5	4	5	3.5	2	8	5	4
80	120	0	-10	0	-8	0	-5	10	8	5	8	6	5	5	4	2.5	10	6	5
120	150	0	-11	0	-9	0	-5	11	9	5	8	7	5	6	5	2.5	11	7	5
150	180	0	-13	0	-10	0	-7	13	10	7	10	8	7	7	5	3.5	13	8	5
180	250	0	-15	0	-11	0	-8	15	11	8	11	8	8	8	6	4	15	10	7
250	315	0	-18	0	-13	0	-8	18	13	8	14	10	8	9	7	4	18	11	7

③ The tolerance of outside diameter deviation ΔDs , applicable to classes 4 and 2, is the same as the tolerance of mean outside diameter deviation ΔDmp . This applies to the diameter series 0 or 2 for class 4, and all the diameter series for class 2.

Inner rings

 Unit : μm

Face runout with bore S_d			Axial runout S_{av}			Width deviation Δ_{Bs}						Width variation V_{Bs}		
Class 5	Class 4	Class 2	Class 5	Class 4	Class 2	Single bearing				Duplex bearing ②		Class 5	Class 4	Class 2
						Class 5	Class 4	Class 2		Class 5	Class 4			
max			max			high	low	high	low	high	low	max		
7	3	1.5	7	3	1.5	0	-40	0	-40	0	-250	5	2.5	1.5
7	3	1.5	7	3	1.5	0	-80	0	-80	0	-250	5	2.5	1.5
8	4	1.5	8	4	2.5	0	-120	0	-120	0	-250	5	2.5	1.5
8	4	1.5	8	4	2.5	0	-120	0	-120	0	-250	5	3	1.5
8	5	1.5	8	5	2.5	0	-150	0	-150	0	-250	6	4	1.5
9	5	2.5	9	5	2.5	0	-200	0	-200	0	-380	7	4	2.5
10	6	2.5	10	7	2.5	0	-250	0	-250	0	-380	8	5	2.5
10	6	4	10	7	5	0	-250	0	-250	0	-380	8	5	4
11	7	5	13	8	5	0	-300	0	-300	0	-500	10	6	5

Outer rings

 Unit : μm

Outside surface inclination S_D			Axial runout S_{av}			Width deviation Δ_{Cs}			Width variation V_{Cs}		
Class 5	Class 4	Class 2	Class 5	Class 4	Class 2	All types			Class 5	Class 4	Class 2
						Class 5	Class 4	Class 2			
max			max						max		
8	4	1.5	8	5	2.5	Identical to of Δ_{Bs}			5	2.5	1.5
8	4	1.5	8	5	2.5	relative to d of the same bearing.			5	2.5	1.5
8	4	1.5	10	5	4				6	3	1.5
9	5	2.5	11	6	5				8	4	2.5
10	5	2.5	13	7	5	8	5	2.5			
10	5	2.5	14	8	5	8	5	2.5			
11	7	4	15	10	7	10	7	4			
13	8	5	18	10	7	11	7	5			

2. Ball Screw Support Bearings

Inner rings

Unit : μm

Nominal bore diameter d		Single plane mean bore diameter deviation Δ_{dmp}						Width variation V_B			Radial runout K_{ra}			Face runout with bore S_d			Axial runout S_a			Width deviation Δ_B					
mm	over incl.	Class 5		Class 4 Φ		Class UP Φ		Class 5	Class 4	Class UP	Class 5	Class 4	Class UP	Class 5	Class 4	Class UP	Class 5	Class 4	Class UP	Class 5		Class 4		Class UP	
		high	low	high	low	high	low													high	low	high	low	high	low
10	18	0	-5	0	-4	0	-3.5	5	2.5	2	3.5	3	2	7	3	2	5	3	2	0	-120	0	-120	0	-100
18	30	0	-6	0	-5	0	-3.5	5	2.5	2	4	3	2	8	4	3	5	3	2	0	-120	0	-120	0	-100
30	50	0	-8	0	-6	0	-5	5	3	2	5	4	3	8	4	3	6	3	2	0	-120	0	-120	0	-100
50	80	0	-9	0	-7	0	-5	6	4	3	5	4	4	8	5	4	7	4	3	0	-150	0	-150	0	-150

① The tolerance of outside diameter deviation Δds applicable to classes 4 and UP is the same as the tolerance of single plane mean outside diameter deviation Δdmp .

Outer rings

Unit : μm

Nominal bore diameter D		Single plane mean outside diameter deviation Δ_{Dmp}						Width variation V_G			Radial runout K_{ra}			Outside surface inclination S_D			Axial runout S_a			Width deviation Δ_G					
mm	over incl.	Class 5		Class 4 Φ		Class UP Φ		Class 5	Class 4	Class UP	Class 5	Class 4	Class UP	Class 5	Class 4	Class UP	All classes	All classes	Class 5		Class 4		Class UP		
		high	low	high	low	high	low												high	low	high	low	high	low	high
30	50	0	-7	0	-6	0	-5	5	2.5	2	7	5	4	8	4	3	Identical to S_{ia} relative to d on the same bearing.	Identical to ΔBs relative to d on the same bearing.							
50	80	0	-9	0	-7	0	-5	6	3	2	8	5	4	8	4	3									
80	120	0	-10	0	-8	0	-7	8	4	3	10	6	4	9	5	4									

② The tolerance of outside diameter deviation ΔDs applicable to classes 4 and UP is the same as the tolerance of single plane mean outside diameter deviation ΔDmp .

3. Cylindrical Roller Bearings

Inner rings

 Unit : μm

Nominal bore diameter		Single plane mean bore diameter deviation Δ_{dmp}						Single radial plane bore diameter variation V_{Dp}						Mean bore diameter deviation V_{Dmp}			Inner ring radial runout K_{ri}					
d		Class 5		Class 4 ^①		Class 2 ^①		Diameter series 9			Diameter series 0			Class 5			Class 4			Class 2		
over	incl.	high	low	high	low	high	low	Class 5 max	Class 4	Class 2	Class 5 max	Class 4	Class 2	Class 5 max	Class 4	Class 2	Class 5 max	Class 4	Class 2	Class 5 max	Class 4	Class 2
18	30	0	-6	0	-5	0	-2.5	6	5	2.5	5	4	2.5	3	2.5	1.5	4	3	2.5	4	3	2.5
30	50	0	-8	0	-6	0	-2.5	8	6	2.5	6	5	2.5	4	3	1.5	5	4	2.5	5	4	2.5
50	80	0	-9	0	-7	0	-4	9	7	4	7	5	4	5	3.5	2	5	4	2.5	5	4	2.5
80	120	0	-10	0	-8	0	-5	10	8	5	8	6	5	5	4	2.5	6	5	2.5	6	5	2.5
120	150	0	-13	0	-10	0	-7	13	10	7	10	8	7	7	5	3.5	8	6	2.5	8	6	2.5
150	180	0	-13	0	-10	0	-7	13	10	7	10	8	7	7	5	3.5	8	6	5	8	6	5
180	250	0	-15	0	-12	0	-8	15	12	8	12	9	8	8	6	4	10	8	5	10	8	5
250	315	0	-18	-	-	-	-	18	-	-	14	-	-	9	-	-	13	-	-	13	-	-
315	400	0	-23	-	-	-	-	23	-	-	18	-	-	12	-	-	15	-	-	15	-	-
400	500	-	-	-	-	-	-	-	-	-	-	-	-	-	-	-	-	-	-	-	-	-

① The tolerance of bore diameter deviation Δd_s applicable to classes 4 and 2 is the same as the tolerance of single plane mean bore diameter deviation Δd_{mp} .

Outer rings

 Unit : μm

Nominal bore diameter		Single plane mean outside diameter deviation Δ_{Dmp}						Single radial plane outside diameter variation V_{Dp}						Mean single plane outside diameter variation V_{Dmp}			Outer ring radial runout K_{ro}					
D		Class 5		Class 4 ^②		Class 2 ^②		Diameter series 9			Diameter series 0			Class 5			Class 4			Class 2		
over	incl.	high	low	high	low	high	low	Class 5 max	Class 4	Class 2	Class 5 max	Class 4	Class 2	Class 5 max	Class 4	Class 2	Class 5 max	Class 4	Class 2	Class 5 max	Class 4	Class 2
30	50	0	-7	0	-6	0	-4	7	6	4	5	5	4	4	3	2	7	5	2.5	7	5	2.5
50	80	0	-9	0	-7	0	-4	9	7	4	7	5	4	5	3.5	2	8	5	4	8	5	4
80	120	0	-10	0	-8	0	-5	10	8	5	8	6	5	5	4	2.5	10	6	5	10	6	5
120	150	0	-11	0	-9	0	-5	11	9	5	8	7	5	6	5	2.5	11	7	5	11	7	5
150	180	0	-13	0	-10	0	-7	13	10	7	10	8	7	7	5	3.5	13	8	5	13	8	5
180	250	0	-15	0	-11	0	-8	15	11	8	11	8	8	8	6	4	15	10	7	15	10	7
250	315	0	-18	0	-13	0	-8	18	13	8	14	10	8	9	7	4	18	11	7	18	11	7
315	400	0	-20	0	-15	0	-10	20	15	10	15	11	10	10	8	5	20	13	8	20	13	8
400	500	0	-23	-	-	-	-	23	-	-	17	-	-	12	-	-	23	-	-	23	-	-
500	630	0	-28	-	-	-	-	28	-	-	21	-	-	14	-	-	25	-	-	25	-	-
630	800	0	-35	-	-	-	-	35	-	-	26	-	-	18	-	-	30	-	-	30	-	-

② The tolerance of outside diameter deviation Δs applicable to classes 4 and 2 is the same as the tolerance of mean single plane outside diameter deviation Δd_{mp} .

Inner rings

Unit :

μm

Face runout with bore S_d			Width deviation Δ_{Bs}				Width variation V_{Bs}		
Class 5	Class 4	Class 2	Class 5	Class 4	Class 2		Class 5	Class 4	Class 2
	max		high	low	high	low		max	
8	4	1.5	0	-120	0	-120	5	2.5	1.5
8	4	1.5	0	-120	0	-120	5	3	1.5
8	5	1.5	0	-150	0	-150	6	4	1.5
9	5	2.5	0	-200	0	-200	7	4	2.5
10	6	2.5	0	-250	0	-250	8	5	2.5
10	6	4	0	-250	0	-300	8	5	4
11	7	5	0	-300	0	-350	10	6	5
13	-	-	0	-350	-	-	13	-	-
15	-	-	0	-400	-	-	15	-	-
-	-	-	0	-	-	-	-	-	-

Outer rings

Unit :

μm

Outside surface inclination S_D			Width deviation Δ_{Cs}				Width variation V_{Cs}		
Class 5	Class 4	Class 2	All classes				Class 5	Class 4	Class 2
	max							max	
8	4	1.5					5	2.5	1.5
8	4	1.5					6	3	1.5
9	5	2.5					8	4	2.5
10	5	2.5					8	5	2.5
10	5	2.5					8	5	2.5
11	7	4	Identical to Δ_{Bs} relative to d on the same bearing.				10	7	4
13	8	5					11	7	5
13	10	7					13	8	7
15	-	-					15	-	-
18	-	-					18	-	-
20	-	-	20	-	-				

Appendix IV : Method of Measuring Face Height Difference(Offset) of Combined Angular Contact Ball Bearings

“Flush grinding” is a finishing technique in which the front and back faces of the inner and outer rings are aligned with each other to eliminate differences in face height illustrated in Fig. 1.4. Furthermore, a negative difference or offset shown in the figure means preload is generated while a positive difference or offset means axial clearance exists.

Fig.1.4 Flush grinding

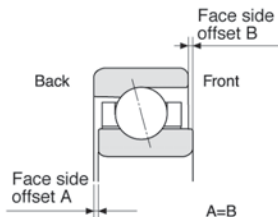

In the case of a DB arrangement, consider put a bearing on the left hand side of above figure with back side next to back side as shown in Fig. 5.2. The face height difference or offset is $-2 \delta_{aoA}$.

In the case of a DB arrangement, place the bearing without the inner-ring spacer on the cradle as described in the figure below, then apply measuring load to the inner ring. After the bearing is sufficiently stabilized, set the dial gauge to zero. Next, after removing the outer-ring spacer, place the bearing with the inner-ring spacer on the cradle and apply measuring load in the same way as above. The reading of dial gauge this time indicates the height difference or offset.

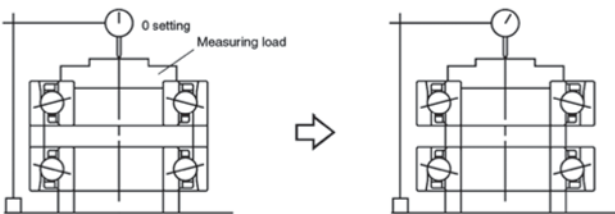

In the case of a DF arrangement, place the bearing without the outer-ring spacer on the cradle as described in the figure below, then apply measuring load to the outer ring. After the bearing is sufficiently stabilized, set the dial gauge to zero. Next, after removing the inner-ring spacer, place the bearing with the outer-ring spacer on

the cradle and apply measuring load in the same way as above. The reading of dial gauge this time indicates the height difference or offset.

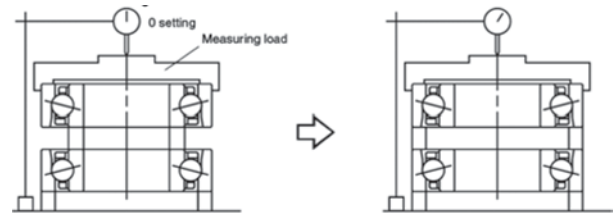
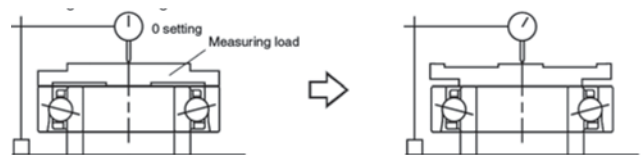

Table 5.9 lists the measured face height difference or offset of a DB or DF arrangement determined by this method. Please refer to the measuring load of face height or offset to Table 5.2.

In the case of single row arrangement, to measure back side offset, place the bearing on the inner-ring spacer. Place special measuring tool and apply measuring load to the outer ring on the bearing as described in the figure below, then apply measuring load to the inner ring. After the bearing is sufficiently stabilized, set the dial gauge to zero. Next, turn over the special tool on the inner ring. The reading of dial gauge this time indicates the height difference or offset of back side.



To measure faceside offset, place the bearing on the outer-ring spacer. Place special measuring tool and apply measuring load to the inner ring on the bearing as described in the figure below, then apply measuring load to the outer ring. After the bearing is sufficiently stabilized, set the dial gauge to zero. Next, turn over the special tool on the outer ring. The reading of dial gauge this time indicates the height difference or offset of front side.



Appendix V : Physical and Mechanical Properties of Materials

Material(code)		Specific gravity	Coefficient of linear expansion (0°C~100°C)	Hardness1) (HB)	Young's modulus Mpa {kgf/mm ² }	Tensile strength Mpa {kgf/mm ² }	Yield point Mpa {kgf/mm ² }	Elongation (%)
Bearing steel(hardened) (SUJ2)		7.83	12.5×10^{-6}	650~740	208000 {21200}	1570~1960 {160~200}	—	—
Stainless steel (SUS 440C)		7.68	10.1×10^{-6}	580	200000 {20400}	1960 {200}	1860 {190}	—
Low carbon steel (0.12~0.20%C)		7.86	12.6×10^{-6}	100~130	206000 {21000}	373~471 {38~48}	216~294 {22~30}	24~36
Medium carbon steel (0.3~0.5%C)		7.84	12.3×10^{-6}	160~200	206000 {21000}	539~686 {55~70}	333~451 {34~46}	14~26
Austenitic stainless steel (SUS 304)		8.03	116.3×10^{-6}	150	193000 {19700}	588 {60}	245 {25}	60
Cast iron	Gray iron FC 200	7.3	10.4×10^{-6}	223	98100 {10000}	200 Min. {20} Min.	—	—
	Spheroidal graphite iron FCD 400	7.0	12.7×10^{-6}	201以下		400 Min. {41} Min.	—	12 Min.
Aluminum		2.69	23.7×10^{-6}	15~26	70600 {7200}	78 {8}	34 {3.5}	35
Zinc		7.14	31×10^{-6}	30~60	92200 {9400}	147 {15}	—	30~40
Copper		8.93	16.2×10^{-6}	50	123000 {12500}	196 {20}	69 {7}	15~20
Brass	(annealed)	8.5	19.1×10^{-6}	About 45	103000 {10500}	294~343 {30~35}	—	65~75
	(machined)			85~130		363~539 {37~55}		15~50

Note: 1) The hardness is usually expressed using the Rockwell C scale, but for comparison, it is converted into Brinell hardness.