

NB



PACIFIC INTERNATIONAL BEARING SALES, INC.
800.228.8895 • WWW.PACIFICBEARINGSALES.COM

SLIDE SHAFT PRODUCTS



**NIPPON
BEARING CO., LTD.**

NB

Corporation of America

July 15th, 1999

SLIDE SHAFT PRODUCTS

The **NB** slide shaft is case hardened and ground steel shafting. Since the linear shaft acts as the inner race of a ball bushing, the specifications such as surface hardness, depth of hardness, surface roughness, cylindricity, and straightness are very important factors for bearing life. **NB** slide shafts are manufactured to required linear motion specifications.

NB carries stock on (g6) ISO tolerance shafts for high grade bearings and h5 tolerance for precision grade bearings. Shaft diameters 1/4" to 2" and also (440C) stainless steel shafts in (g6) tolerance 1/8" to 1" are available for applications requiring corrosion resistance. For open type linear motion bearings, standard pre-drilled shafts are also available.

Introduction/Design Features

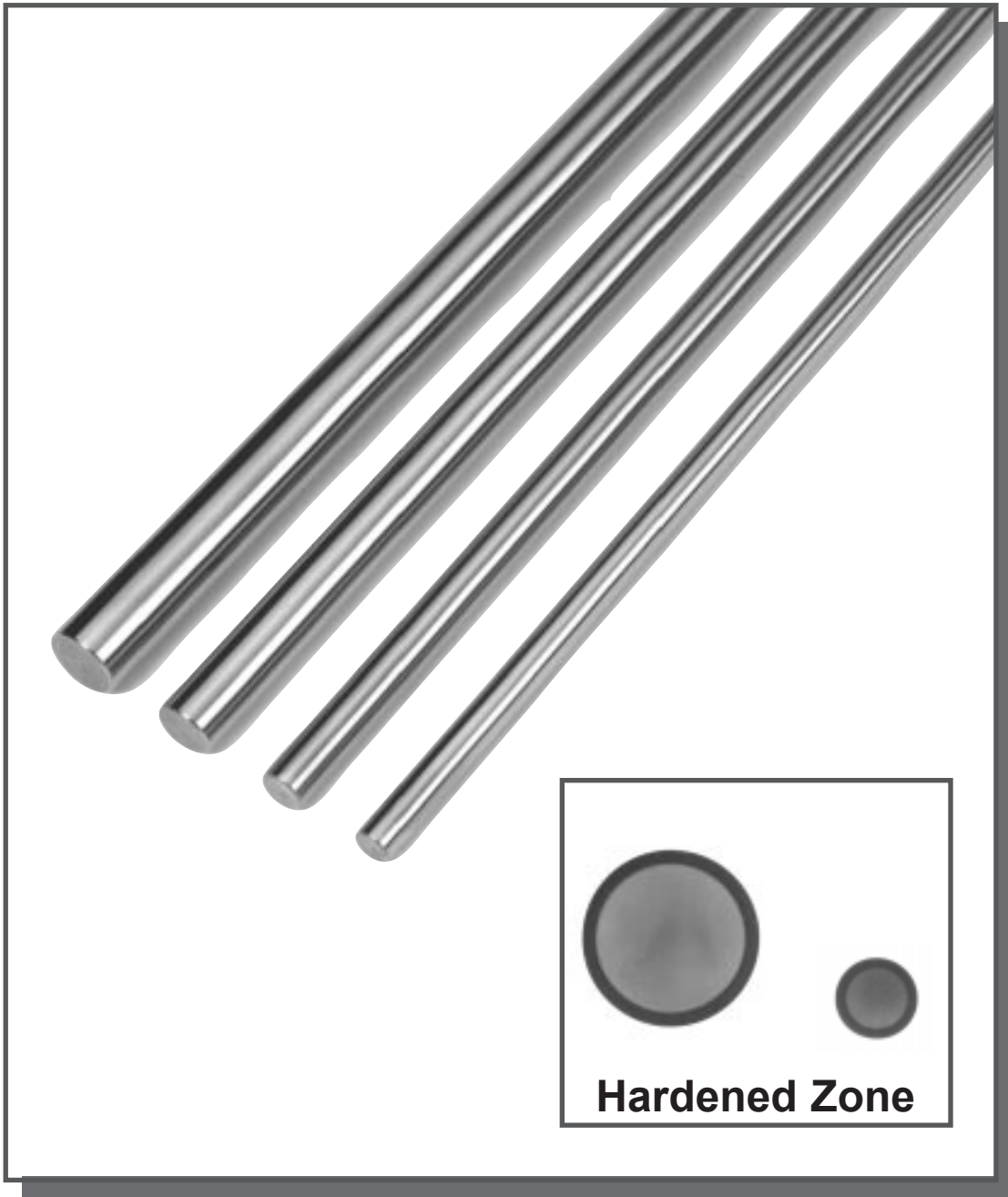

Specification of NB Slide Shafts

Materials

Materials of **NB** slide shafts are selected *AISI 52100*, *1060*, and *440C* (or equivalent) on the basis of hardenability, fatigue strength, wear resistance, and toughness.

AISI 52100 High carbon chromium bearing steel
Most-used steel for bearings

AISI 1060 High carbon alloy steel
The most popular steel in linear motion shafts

AISI 440C Martensite stainless steel
A hardenable stainless steel

Other materials may also be available, please contact **NB**

Heat Treatment

NB slide shafts are case hardened with controlled surface hardness and consistent adequate hardness depth. If the hardness depth is not great enough it will cause early failure to both the shaft and bushing.

NB controls the surface hardness by using high frequency induction hardening techniques. The surface hardness for SFW type (*AISI 52100* or *1060* shafts) is 60-64 Rc, SFWS Stainless type (*AISI 440C* or equivalent shafts) is 52-56 Rc.

Surface Roughness & Straightness

NB slide shafts are finished to a surface roughness of 10-16 micro inches RMS. Straightness of shafts is maintained at 0.001" - 0.002" per foot.

Surface finish of shafting must be kept consistent to maintain proper operation of bushing and to maintain the proper life of the bearing system.

Diameter Tolerance and Length Tolerance

NB recommends (g6) ISO tolerance shafting for standard high grade linear motion bearings and (h5) ISO tolerance for precision grade linear motion bearings. Both (g6) & (h5) tolerance shafting are available from stock in particular standard lengths or can be cut to special lengths with a tolerance of $\pm 1/32$ " for less than 2" diameter shafts, and $\pm 1/16$ " for over 2" diameter. The maximum standard length of (g6) tolerance shafting is available in continuous usable length but with rough ends. The maximum standard length of (h5) tolerance are available in continuous usable length with finished ends. **NB's** maximum standard stock lengths are shown in the table provided. Special diameter tolerance and special length tolerance are also available. Please contact your **NB** sales representative for details.

Slide Shaft Identification System

SFW 24 h5 x 72 - PD

Material

SFW	AISI 52100 OR 1060
SFWS	AISI 440C(or equivalent)

Nominal Shaft Diameter

2	1/8"
3	3/16"
4	1/4"
6	3/8"
8	1/2"
10	5/8"
12	3/4"
16	1"
20	1-1/4"
24	1-1/2"
32	2"

Other

No Entry	Straight Shaft
PD	Pre-Drilled
M	Custom Shaft

Over All Length In Inch

Tolerance

No Entry	ISO g6
h5	ISO h5

Standard Material & Stainless Steel Slide Shafts



TABLE 1: STANDARD MATERIAL SLIDE SHAFTS

NOM. SHAFT DIA. (inch)	STANDARD GRADE			PRECISION GRADE			MINIMUM HARDNESS DEPTH (inch)	WEIGHT PER INCH (lb)
	NB PART NUMBER	TOL. ISO g6 (inch)	STOCKED MAX* LGTH (inch)	NB PART NUMBER	TOL. ISO h5 (inch)	STOCKED MAX* LGTH (inch)		
1/4"	SFW 4xL	-0.0002 -0.0006	165"	SFW 4(h5)xL	0 -0.00025	39	0.03	0.014
3/8"	SFW 6xL	-0.0002 -0.0006	157"	SFW 6(h5)xL	0 -0.00025	39	0.03	0.031
1/2"	SFW 8xL	-0.0002 -0.0007	161"	SFW 8(h5)xL	0 -0.00030	78	0.03	0.056
5/8"	SFW 10xL	-0.0002 -0.0007	157"	SFW 10(h5)xL	0 -0.00030	78	0.05	0.087
3/4"	SFW 12xL	-0.0003 -0.0008	120"	SFW 12(h5)xL	0 -0.00035	78	0.06	0.125
1"	SFW 16xL	-0.0003 -0.0008	144"	SFW 16(h5)xL	0 -0.00035	78	0.06	0.222
1-1/4"	SFW 20xL	-0.0004 -0.0010	180"	SFW 20(h5)xL	0 -0.00045	78	0.08	0.347
1-1/2"	SFW 24xL	-0.0004 -0.0010	180"	SFW 24(h5)xL	0 -0.00045	78	0.08	0.500
2"	SFW 32xL	-0.0004 -0.0011	180"	SFW 32(h5)xL	0 -0.00050	78	0.08	0.889

*CONTACT NB FOR CURRENT MAXIMUM LENGTH.

Surface Hardness: RC 60-64
Material: AISI 5100 1060

TABLE 2: STAINLESS STEEL SLIDE SHAFTS

NOM. SHAFT DIA. (inch)	NB PART NUMBER	TOL. ISO g6 (inch)	STOCKED MAX* LGTH (inch)	MINIMUM HARDNESS DEPTH (inch)	WEIGHT PER INCH (lb)
1/8"	SFWS 2XL	-0.0002 -0.0005	8"	0.03	0.004
3/16"	SFWS 3XL	-0.0002 -0.0005	12"	0.03	0.008
1/4"	SFWS 4xL	-0.0002 -0.0006	78"	0.03	0.014
3/8"	SFWS 6xL	-0.0002 -0.0006	137"	0.03	0.031
1/2"	SFWS 8xL	-0.0002 -0.0007	157"	0.03	0.056
5/8"	SFWS 10xL	-0.0002 -0.0007	157"	0.05	0.087
3/4"	SFWS 12xL	-0.0003 -0.0008	196"	0.06	0.125
1"	SFWS 16xL	-0.0003 -0.0008	236"	0.06	0.222

*CONTACT NB FOR CURRENT MAXIMUM LENGTH.

Surface Hardness: RC 52-56
Material: AISI 440C (or equivalent)



Pre-Drilled Shafts

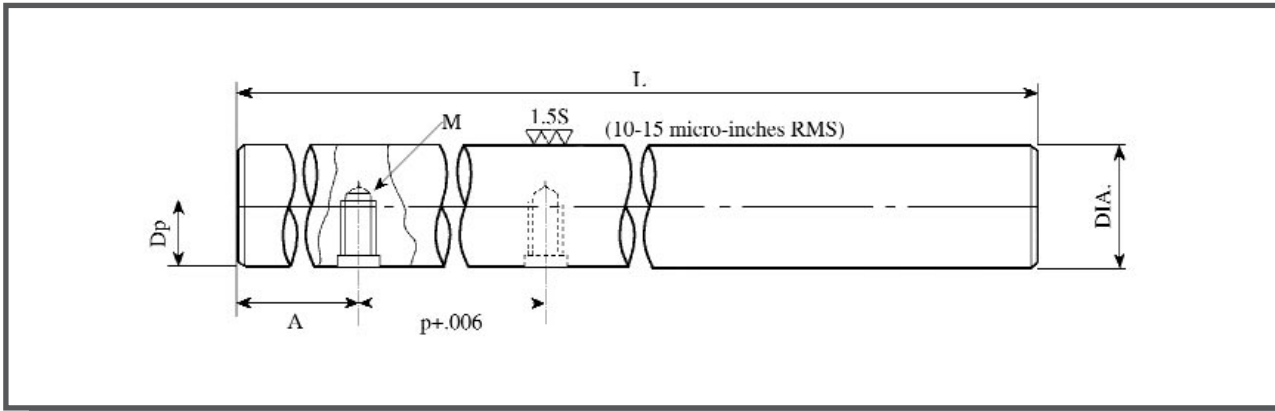

TABLE 3: PRE-DRILLED SHAFTS

NOM. SHAFT DIA. (inch)	NB PART NUMBER	TOL. ISO g6 (inch)	STOCKED MAX* LGTH (inch)	HOLE SPACING		STANDARD THREAD		MINIMUM HARDNESS DEPTH (inch)	WEIGHT PER INCH (lb)
				A (inch)	P (inch)	M	Dp (inch)		
1/2"	SFW 8xL-PD	-0.0002 -0.0007	72	2	4	6-32 UNC	0.28	0.03	0.056
5/8"	SFW 10xL-PD	-0.0002 -0.0007	72	2	4	8-32 UNC	0.35	0.05	0.087
3/4"	SFW 12xL-PD	-0.0003 -0.0008	72	3	6	10-32 UNC	0.40	0.06	0.125
1"	SFW 16xL-PD	-0.0003 -0.0008	72	3	6	1/4-20 UNC	0.50	0.06	0.222
1-1/4"	SFW 20xL-PD	-0.0004 -0.0010	72	3	6	5/16-18 UNC	0.65	0.08	0.347
1-1/2"	SFW 24xL-PD	-0.0004 -0.0010	72	4	8	3/8-16 UN	0.70	0.08	0.500
2"	SFW 32xL-PD	-0.0004 -0.0011	72	4	8	1/2-13 UNC	0.85	0.09	0.889

*CONTACT NB FOR CURRENT MAXIMUM LENGTH.

Surface Hardness: RC 60-64
Material: AISI 5100 1060

Pre-Cut Slide Shafts

TABLE 4: PRE-CUT SLIDE SHAFTS

NB Part Number Prefix	Length (inch) (L)	Nominal Diameter	Diameter Tolerances From ~ To	Standard Lengths (inch) (L)									
				6	12	18	24	30	36	42	48		
PC	4 - ##	.250"	.2498" ~ .2494"	◆	◆	◆	◆						
PC	6 - ##	.375"	.3748" ~ .3744"	◆	◆	◆	◆						
PC	8 - ##	.500"	.4998" ~ .4993"		◆	◆	◆	◆	◆				
PC	10 - ##	.625"	.6248" ~ .6243"		◆	◆	◆	◆	◆				
PC	12 - ##	.750"	.7497" ~ .7492"			◆	◆	◆	◆	◆			◆
PC	16 - ##	1.000"	.9997" ~ .9992"			◆	◆	◆	◆	◆	◆		◆
PC	20 - ##	1.250"	1.2496" ~ 1.2490"			◆	◆	◆	◆	◆	◆		◆
PC	24 - ##	1.500"	1.4996" ~ 1.4990"			◆	◆		◆				◆

Custom Shafts

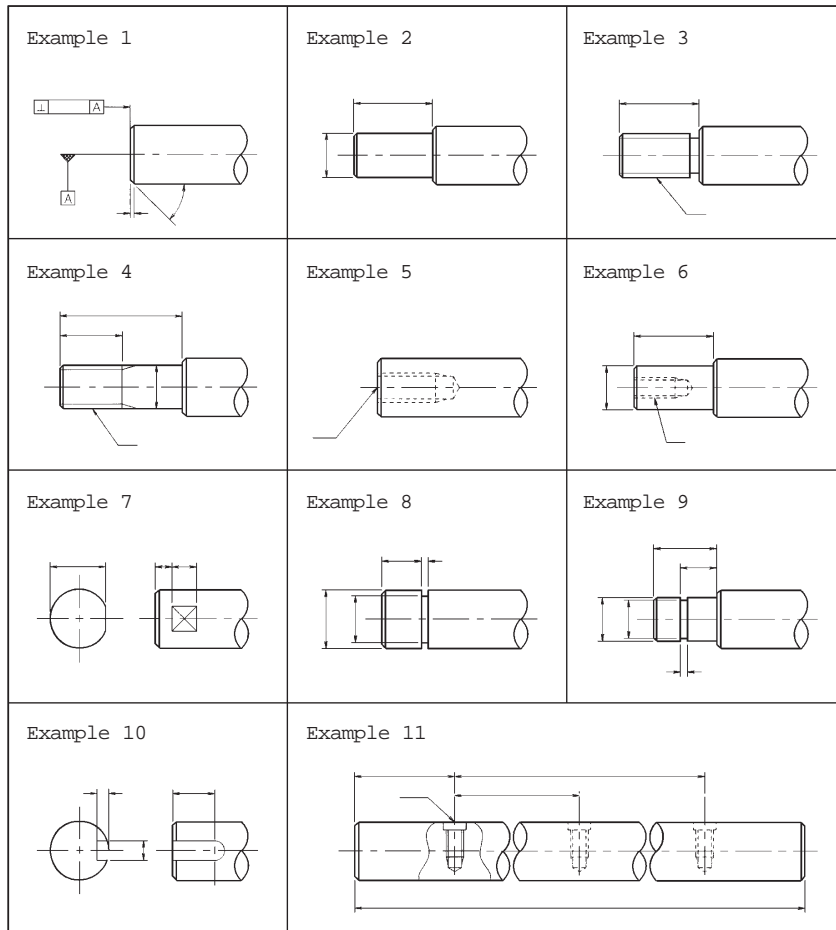

Example 1.
Special Chamfer & Length

Example 2.
Reduced Diameter

Example 3-4.
External Thread

Example 5.
Tapped Hole

Example 6.
Reduced Diameter & Tapped Hole

Example 7.
Flats

Example 8.
External Ring Groove

Example 9.
Reduced Diameter & External Ring Groove

Example 10.
Key Way

Example 11.
Tapped Holes (radial)

NB can offer many custom machined shafts, such as spindles, guide rods, control rods, mandrels, quills, rollers, etc. Please contact our sales representative for details. All machined shaft requests for quotation must be accompanied with a drawing.

Note 1:
Recommended maximum tap diameter in example 5 is half of the nominal shaft diameter or slightly larger.

Note 2:
In the case of small diameter stainless shafts, the hardness depth may be too deep for additional machining.

Shaft Deflection and Angle

As Shafts are used for guideways it becomes important that shaft deflection constraints be maintained within certain limits under load. Deflection under load must be maintained otherwise the functioning and service life of the linear bearing assembly could be reduced and cause premature failures.

To aid in the determination of the shaft deflection and its angle, we have established a list of the most common loading conditions and the appropriate calculations for the selected condition. The table below shows the conditions and calculations for the deflection and its angle.

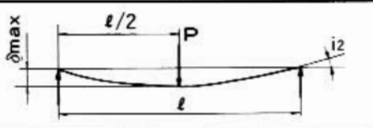
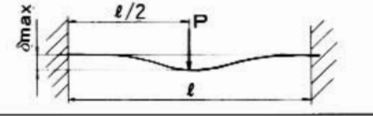
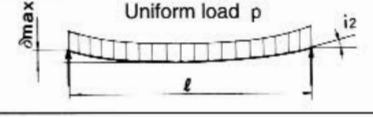
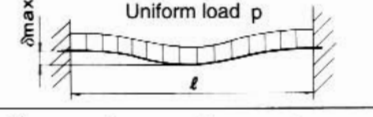
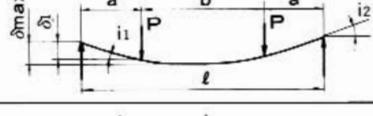
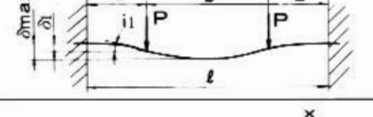
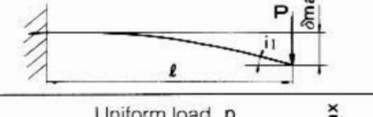
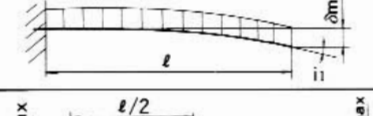
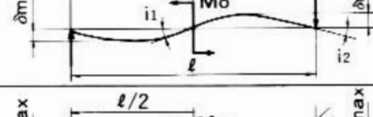
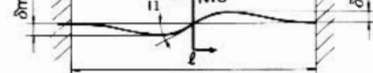
	Supporting method	Specified conditions	Deflection equation	Deflection angle equation
1	Free at both ends		$\delta_{\max} = \frac{P\ell^3}{48EI} = P\ell^3C$	$i_1 = 0$ $i_2 = \frac{P\ell^2}{16EI} = P\ell^2C$
2	Fixed at both ends		$\delta_{\max} = \frac{P\ell^3}{192EI} = \frac{1}{4}P\ell^3C$	$i_1 = 0$ $i_2 = 0$
3	Free at both ends		$\delta_{\max} = \frac{5p\ell^4}{384EI} = \frac{5}{8}p\ell^4C$	$i_2 = \frac{p\ell^3}{24EI} = 2p\ell^3C$
4	Fixed at both ends		$\delta_{\max} = \frac{p\ell^4}{384EI} = \frac{1}{8}p\ell^4C$	$i_2 = 0$
5	Free at both ends		$\delta_1 = \frac{Pa^3}{6EI} \left(2 + \frac{3b}{a}\right) = 8Pa^3 \left(2 + \frac{3b}{a}\right)C$ $\delta_{\max} = \frac{Pa^3}{24EI} \left(\frac{3\ell^2}{a^2} - 4\right) = 2Pa^3 \left(\frac{3\ell^2}{a^2} - 4\right)C$	$i_1 = \frac{Pab}{2EI} = 24PabC$ $i_2 = \frac{Pa(a+b)}{2EI} = 24Pa(a+b)C$
6	Fixed at both ends		$\delta_1 = \frac{Pa^3}{6EI} \left(2 - \frac{3a}{\ell}\right) = 8Pa^3 \left(2 - \frac{3a}{\ell}\right)C$ $\delta_{\max} = \frac{5}{8}p\ell^4C = 0.27(\text{mm})$	$i_1 = \frac{Pa^2b}{2EI \cdot \ell} = \frac{24Pa^2bC}{\ell}$ $i_2 = 0$
7	Fixed at one end		$\delta_{\max} = \frac{P\ell^3}{3EI} = 16P\ell^3C$	$i_1 = \frac{P\ell^2}{2EI} = 24P\ell^2C$ $i_2 = 0$
8	Fixed at one end		$\delta_{\max} = \frac{p\ell^4}{8EI} = 6p\ell^4C$	$i_1 = \frac{p\ell^3}{6EI} = 8p\ell^3C$ $i_2 = 0$
9	Free at both ends		$\delta_{\max} = \frac{\sqrt{3}Mo\ell^2}{216EI} = \frac{2\sqrt{3}}{9}Mo\ell^2C$	$i_1 = \frac{Mo\ell}{12EI} = 4Mo\ell C$ $i_2 = \frac{Mo\ell}{24EI} = 2Mo\ell C$
10	Fixed at both ends		$\delta_{\max} = \frac{Mo\ell^2}{216EI} = \frac{2}{9}Mo\ell^2C$	$i_1 = \frac{Mo\ell}{16EI} = 3Mo\ell C$ $i_2 = 0$

Σf_1 : Deflection at loaded point (mm)

Σf_{\max} : Maximum deflection (mm)

i_1 : Deflection angle at loading point

i_2 : Deflection angle at supporting point

M_o : Moment (N*mm)

P: Concentrated load (N)

p: Uniform load (N/mm)

a,b: Loading point distance (mm)

l: Span (mm)

I: Geometrical moment of inertia (mm⁴)

E: Modulus of direct elasticity 2.1 x 10⁵ (N/mm²)

C: 1/48EI (1/N*mm²)