



■ TSK Miniature Type LMBM Series



▶ 構造 Construction :

TSK ミニチュアタイプ LMBM・LMBM-W シリーズの転動面は、2つの円弧で形成されたゴシックアーチ形状に精密加工されています。コンパクトなブロック内に施された2条列転動面とレールの間をボールが無制限循環運動をします。

The raceways of TSK miniature-type LMBM series are processed by precision machining into Gothic arch carved in two circular arcs. The steel balls move in an unlimited circulation between the rail and the two lines of grooves machined in the compact block.

▶ 特長 Features :

- ・コンパクトな取付を可能にした省スペースタイプです。
- ・精密研削加工により、小径・低転がり抵抗でありながら、高剛性を実現。
- ・多様な環境に対応する為、ステンレス仕様を標準化しています。
- ・エンドシール有無の選択が可能です。
- ・当社独自製法により低価格を実現しています。

TSK miniature LMB guide features the space-saving construction which enables the customer to mount it compactly. Its high rigidity is ensured by the precision grinding, though it is of small size and has low traveling resistance. To cope with various situations, the specifications of the stainless steel model have been standardized. The use of an end seal is also available. Our unique way of manufacturing has enabled us to offer the competitive prices.

▶ 脱落防止 Prevention of Steel Balls from Escaping :

LMBM・LMBM-W シリーズはブロックをレールからはずすとボールが脱落する構造の為、ブロックをレールから抜く場合、空きレールに移しかえる事をおすすめいたします。空きレールについては弊社にお問い合わせ下さい。

Since the LMBM series are constructed in such a way that the balls may escape when the block is removed from the rail, it is recommended to move the block on to a spare rail when it is removed. Please contact TSK for further information on a spare rail.



PACIFIC INTERNATIONAL BEARING SALES, INC.
800.228.8895 • WWW.PACIFICBEARINGSALES.COM

▶ 基本面の表示

Indication of Datum Plane

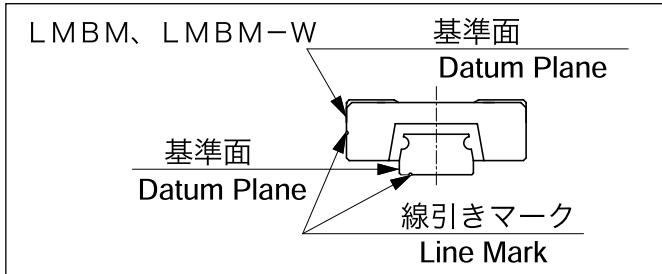

▶ ラジアルすきま

Radial Clearance

[μm]

LMBM 5	0~+1.5
LMBM 7、7W	± 2
LMBM 9、9W	± 2
LMBM12、12W	± 3
LMBM15、15W	± 5
LMBM20	± 7

▶ レール標準長さ Standard Length of Track

型式 Model	LMBM						LMBM-W			
	5	7	9	12	15	20	7	9	12	15
標準長さ Standard Length	40	40	55	70	70	220	50	50	70	110
	55	55	75	95	110	280	80	80	110	150
	70	70	95	120	150	340	110	110	150	190
	100	85	115	145	190	460	140	140	190	230
	130	100	135	170	230	640	170	170	230	270
		130	155	195	270	880	200	200	270	310
			175	220	310		260	260	310	430
			195	245	350		290	290	390	550
			275	270	390				470	670
				320	430					
			370	470						
			470	670						
F	15	15	20	25	40	60	30	30	40	40
E	5	5	7.5	10	15	20	10	10	15	15

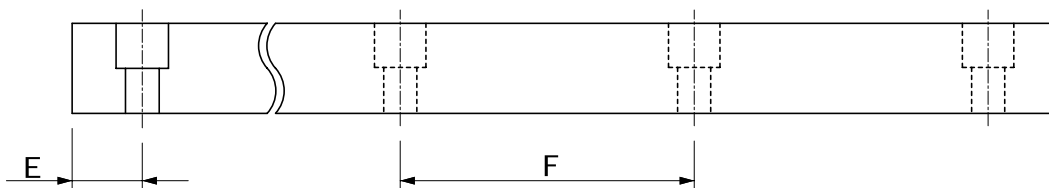

■ 呼び型番 Code Name

LMBM15 - B1 - 470 - W1

型式
Model No.

軌道台全長 (mm)
Length of Track (mm)

同一平面上で使用する軸数
Number of Tracks Used on the Same Plane

一軸に組み合わせるスライドユニット個数
Number of Slide Units on the Track



PACIFIC INTERNATIONAL BEARING SALES, INC.
800.228.8895 • WWW.PACIFICBEARINGSALES.COM

■ TSK Miniature Guides LMBM Series (Standard Type)



型式 Model No.	組込寸法 Mounting dimension			スライドユニット寸法 Slide unit dimension							
	H	H1	N	W1	W2	W3	L1	L2	L3	H3	M1 x ℓ
LMBM 5	6	1.5	3.5	12	8	6	17	8.8	—	—	M2 x 1.5
LMBM 7	8	1.5	5	17	12	2.5	23.5	13.5	8	—	M2 x 2.5
LMBM 9	10	2.2	5.5	20	15	2.5	31	20.0	10	—	M3 x 3
LMBM12	13	3	7.5	27	20	3.5	35	20.8	15	—	M3 x 3.5
LMBM15	16	4	8.5	32	25	3.5	43	25.7	20	—	M3 x 4
LMBM20	25	7.5	13	46	38	4	66.5	45.0	38	6	M4 x 6



PACIFIC INTERNATIONAL BEARING SALES, INC.
800.228.8895 • WWW.PACIFICBEARINGSALES.COM

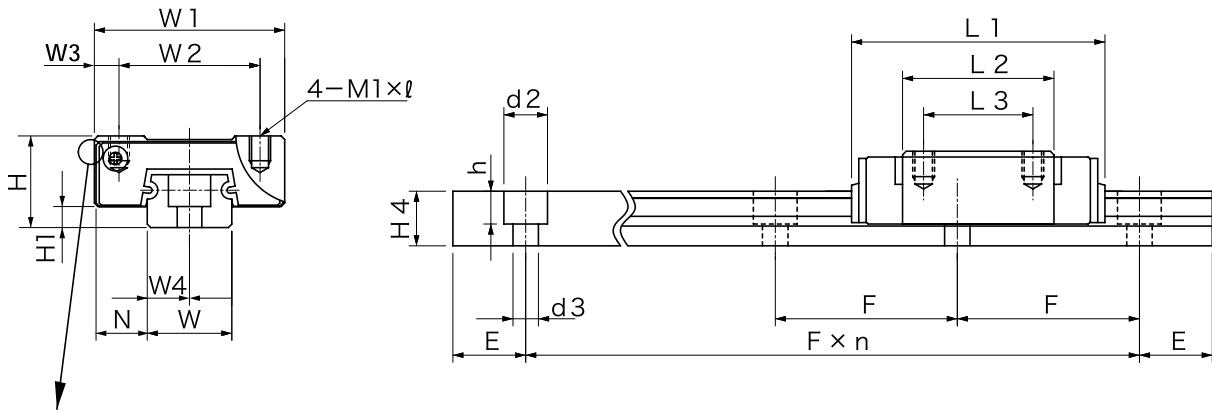

● LMBM20

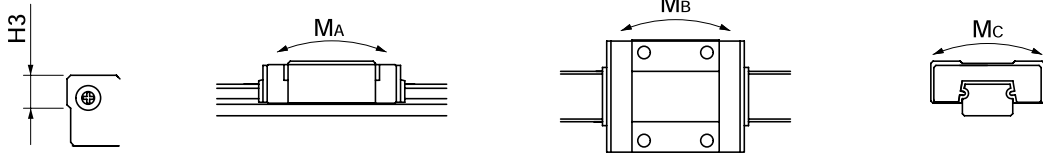

単位 mm

軌道台寸法 Rail track dimension								基本定格荷重 Basic rated load [N]		静定格トルク Rated static torque [N・m]			質量 Weight	
W	W4	H4	d2	d3	h	E	F	C	Co	MA	MB	MC	スライド ユニット Slide Unit [kg]	軌道台 Track [kg/m]
5	2.5	4	3.5	2.4	1	5	15	320	590	0.8	0.8	1.47	0.01	0.14
7	3.5	4.7	4.2	2.4	2.3	5	15	880	1370	2.55	2.55	5.10	0.02	0.23
9	4.5	5.5	6	3.5	3.3	7.5	20	1470	2250	5.10	5.10	10.4	0.02	0.32
12	6	7.5	6	3.5	4.5	10	25	2650	4020	8.04	8.72	14.7	0.04	0.58
15	7.5	9.5	6	3.5	4.5	15	40	4410	6570	16.5	17.9	30.2	0.07	0.93
20	10	15	9.5	6	8.5	20	60	8820	12700	48.8	52.7	75.7	0.25	1.95



PACIFIC INTERNATIONAL BEARING SALES, INC.
800.228.8895 • WWW.PACIFICBEARINGSALES.COM

■ TSK Miniature Guides LMBM-W Series (Wide Type)



● LMBM7W

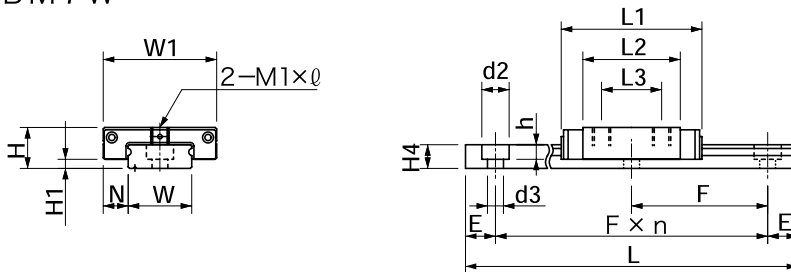

型式 Model No.	組込寸法 Mounting dimension			スライドユニット寸法 Slide unit dimension					
	H	H1	N	W1	W2	L1	L2	L3	M1 x Ø
LMBM 7W	9	2	5.5	25	19	31	21.5	12	M4 x 3.5
LMBM 9W	12	4.2	6	30	21	39	28	12	M2.6 x 3
LMBM12W	14	4	8	40	28	44.5	30.5	15	M3 x 3.5
LMBM15W	16	4	9	60	45	55.5	38.5	20	M4 x 4.5



PACIFIC INTERNATIONAL BEARING SALES, INC.
800.228.8895 • WWW.PACIFICBEARINGSALES.COM

● LMBM9W、12W

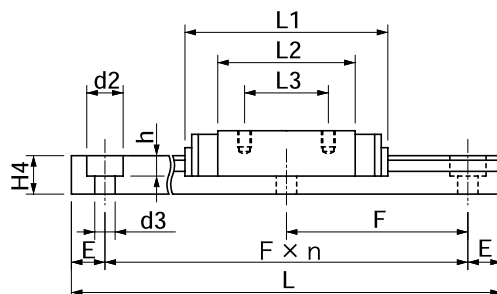
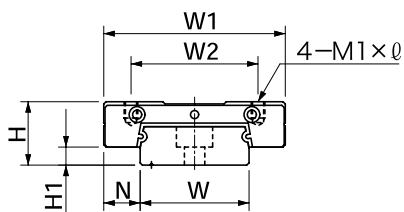

● LMBM15W

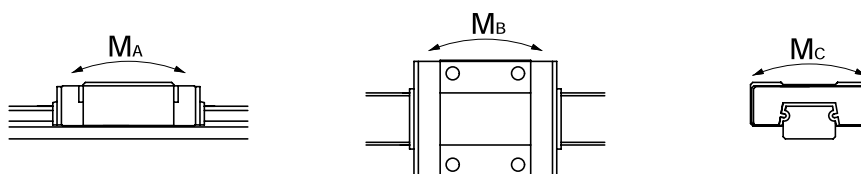
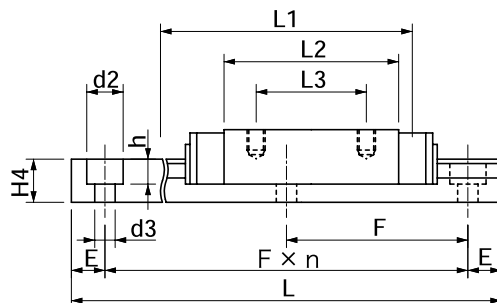
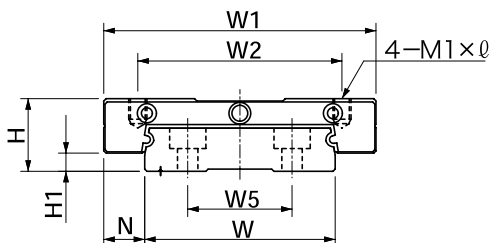

単位 mm

軌道台寸法 Rail track dimension								基本定格荷重 Basic rated load [N]		静定格トルク Rated static torque [N・m]			質量 Weight	
W	H4	W5	d2	d3	h	E	F	C	Co	MA	MB	MC	スライド ユニット Slide Unit [kg]	軌道台 Track [kg/m]
14	5.2	—	6	3.5	3.2	10	30	1370	2160	5.39	5.39	15.2	0.03	0.51
18	7.5	—	6	3.5	4.5	10	30	2450	3920	16.3	16.3	36.0	0.04	1.08
24	8.5	—	8	4.5	4.5	15	40	4020	6080	17.2	18.6	47.6	0.08	1.5
42	9.5	23	8	4.5	4.5	15	40	6660	9800	35.2	38.2	137	0.17	3.0