

Bearing Arrangement Options:

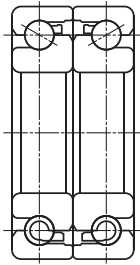

DF

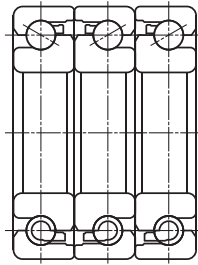

DFT

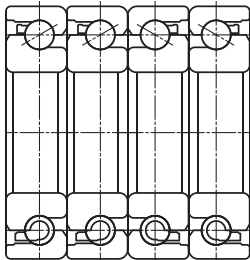

DTBT

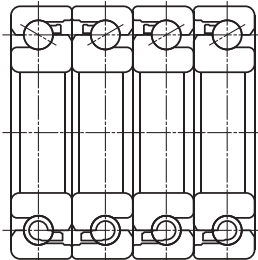

DFTT

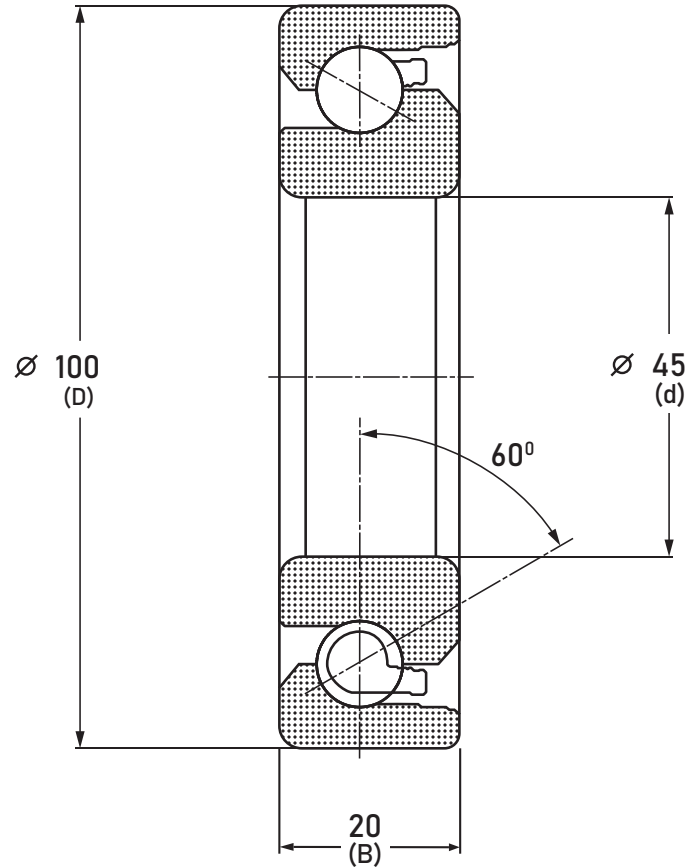

Contact Angle	60° Contact Angle
Bearing Arrangement	Single - Universal Matched
Precision	P4A
Ring Material	SUJ2 Steel
Ball Material	SUJ2 Steel
Preload	Normal Preload
Dynamic Load(Cr)	13.94 lbs
Static Load(C0r)	34.4 lbs
Speed Rating Grease	4400 rpm
Speed Rating Oil	6200 rpm

COMPONENT	SUPER PRECISION ANGULAR CONTACT	
BS45100G/GNP4A TPI 45 mm x 100 mm x 20 mm, Angular Contact Bearing, Ball screw support, Single - Universal Matched	UNIT	
	mm	
	SHEET	



Pacific International Bearing, Inc.
 33258 Central Ave, Union City, CA 94587
 1-800-228-8895, 510-512-7000,
info@pibsales.com
www.pibsales.com
www.pibsales.store

This file and any associated information and specifications are provided for reference and evaluation purposes only, and is subject to change without notice. PIB makes no representations, warranties or guarantees as to the appropriateness, accuracy, completeness, or suitability for any purpose, of the file, information or specifications. You are solely responsible for the use of the file, information or specifications.