

Bearing Arrangement Options:

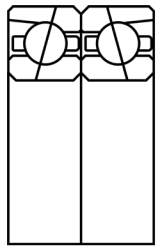

DB

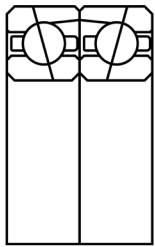

DF

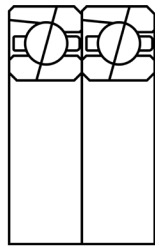

DT

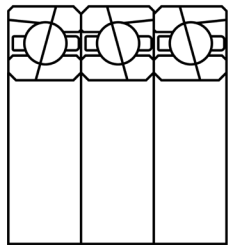

DBT

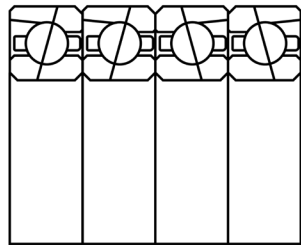

DTBT

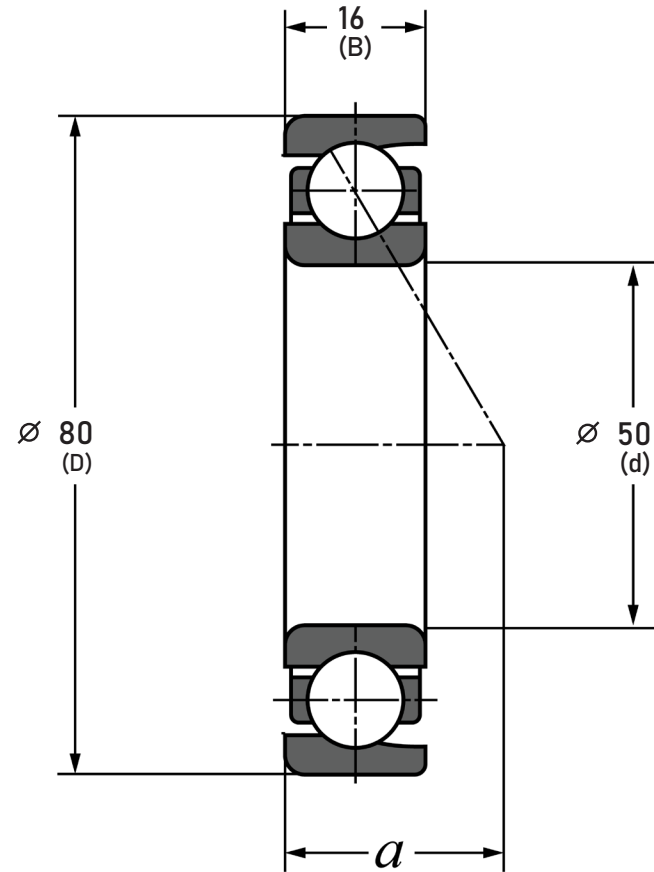

Contact Angle	18° Contact Angle
Bearing Arrangement	Pair - Universal Matched
Precision	P4X
Ring Material	SUJ2 Steel
Ball Material	SUJ2 Steel
Preload	Light Preload
Dynamic Load(Cr)	3.93 lbs
Static Load(C0r)	4.52 lbs
Speed Rating Grease	22800 rpm
Speed Rating Oil	35000 rpm

COMPONENT	SUPER PRECISION ANGULAR CONTACT
-----------	---------------------------------



Pacific International Bearing, Inc.
 33258 Central Ave, Union City, CA 94587
 1-800-228-8895, 510-512-7000,
 info@pibsales.com
 www.pibsales.com
 www.pibsales.store

This file and any associated information and specifications are provided for reference and evaluation purposes only, and is subject to change without notice. PIB makes no representations, warranties or guarantees as to the appropriateness, accuracy, completeness, or suitability for any purpose, of the file, information or specifications. You are solely responsible for the use of the file, information or specifications.

HS010CE1T1LLBD2G
TPI
 50 mm x 80 mm x 16 mm,
 Angular Contact Bearing, 18° Contact Angle,
 Pair - Universal Matched

UNIT
mm
SHEET