

S...1)

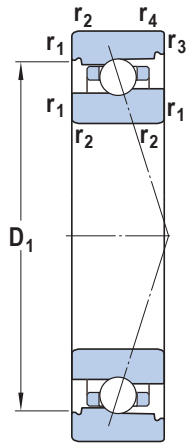

ACB, CB

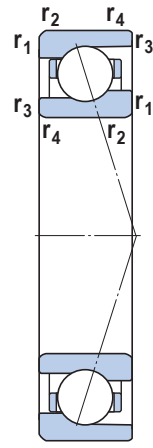

719..ACE,
719..CE

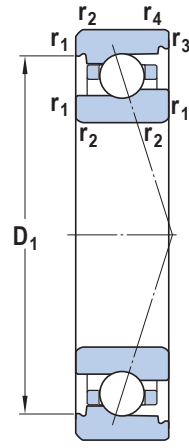

70..ACE,
70..CE

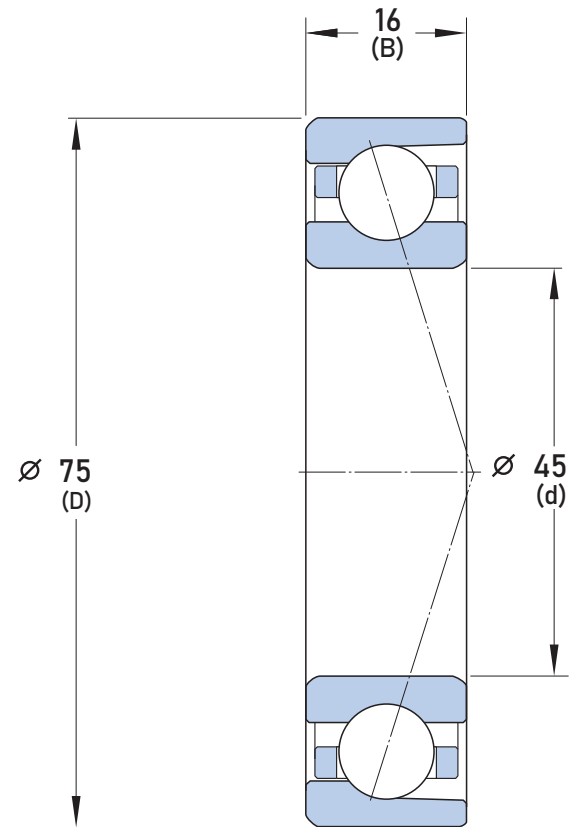

ACD, CD

Contact Angle	15° High-Speed E Design
Bearing Arrangement	Pair - Universal Matched
Precision	P4A
Ring Material	Chrome Steel 100Cr6
Ball Material	Ceramic Si3N4
Preload	Light Preload
Dynamic Load Capacity(Cr)	2922.52 lbs
Static Load Capacity (C0r)	1910.88 lbs
Speed Rating Grease	32,000 rpm
Speed Rating Oil	50,000 rpm
Seal	Rubber Seal

COMPONENT	SUPER PRECISION ANGULAR CONTACT
-----------	------------------------------------



Pacific International Bearing, Inc.
33258 Central Ave, Union City, CA 94587
1-800-228-8895, 510-512-7000,
info@pibsales.com
www.pibsales.com
www.pibsales.store

This file and any associated information and specifications are provided for reference and evaluation purposes only, and is subject to change without notice. PIB makes no representations, warranties or guarantees as to the appropriateness, accuracy, completeness, or suitability for any purpose, of the file, information or specifications. You are solely responsible for the use of the file, information or specifications.

<p>S7009 CE/HCP4ADGA</p> <p>SKF</p> <p>45 mm x 75 mm x 16 mm, Angular Contact Bearing, 15° Contact Angle, Pair - Universal Matched</p>	UNIT
	mm
	SHEET