

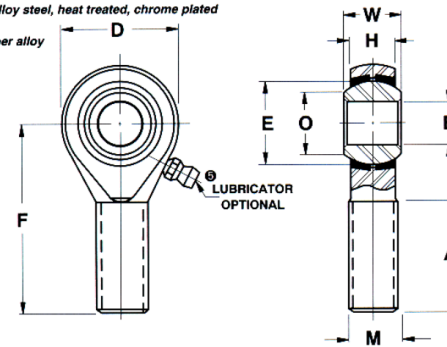

Width (B)	.8750 in
Outer Eye Diameter	.6870 in
Brand	RBC

Ball: 52100 Alloy steel, heat treated, chrome plated
Inserts: Copper alloy



COMPONENT

Rod End



Pacific International Bearing, Inc.
33258 Central Ave, Union City, CA 94587
1-800-228-8895, 510-512-7000,
info@pibsales.com
www.pibsales.com

This file and any associated information and specifications are provided for reference and evaluation purposes only, and is subject to change without notice. PIB makes no representations, warranties or guarantees as to the appropriateness, accuracy, completeness, or suitability for any purpose, of the file, information or specifications. You are solely responsible for the use of the file, information or specifications.

**ARE12N
RBC**

UNIT

INCH

SHEET