

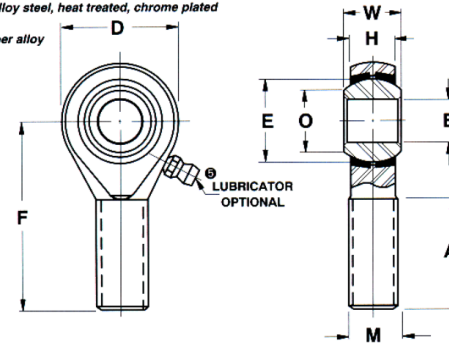

Ball: 52100 Alloy steel, heat treated, chrome plated

Inserts: Copper alloy



Bore Diameter (d)	.5000 in
Outside Diameter (D)	1.3120 in
Width (B)	.6250 in
Outer Eye Diameter	.5000 in
Static Load(C0r)	RBC
Thread Direction	Right Hand
Thread Type	Male



Pacific International Bearing, Inc.
 33258 Central Ave, Union City, CA 94587
 1-800-228-8895, 510-512-7000,
 info@pibsales.com
 www.pibsales.com

This file and any associated information and specifications are provided for reference and evaluation purposes only, and is subject to change without notice. PIB makes no representations, warranties or guarantees as to the appropriateness, accuracy, completeness, or suitability for any purpose, of the file, information or specifications. You are solely responsible for the use of the file, information or specifications.

COMPONENT	Rod End	
ARE820 0.5000in X 1.3120in X 0.6250in, Male Spherical Plain Rod End, 4 Piece - Metal- to-metal, Rbc Spherco - Standard Series, Right Handed, Brass Insert	UNIT	
	Inch	
	SHEET	