

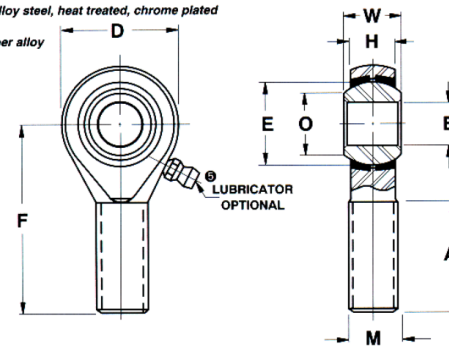

Ball: 52100 Alloy steel, heat treated, chrome plated
Inserts: Copper alloy



Bore Diameter (d)	.3125 in
Outside Diameter (D)	.8750 in
Width (B)	.4370 in
Outer Eye Diameter	.3440 in
Static Load(C0r)	RBC
Thread Direction	Left Handed
Thread Type	Male

COMPONENT	Rod End
-----------	---------



Pacific International Bearing, Inc.
 33258 Central Ave, Union City, CA 94587
 1-800-228-8895, 510-512-7000,
 info@pibsales.com
 www.pibsales.com

This file and any associated information and specifications are provided for reference and evaluation purposes only, and is subject to change without notice. PIB makes no representations, warranties or guarantees as to the appropriateness, accuracy, completeness, or suitability for any purpose, of the file, information or specifications. You are solely responsible for the use of the file, information or specifications.

AREL5 0.3125in X 0.8750in X 0.4370in, Male Spherical Plain Rod End, 4 Piece - Metal- to-metal, Rbc Spherco - Standard Series, Left Handed, Brass Insert
--

UNIT
Inch
SHEET