

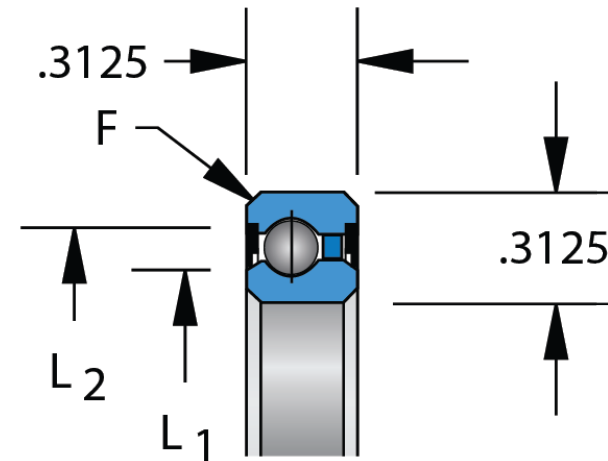

5/32" balls



$$F = .040^6$$

Bore Diameter (d)	4.500 in
Outside Diameter (D)	5.125 in
Width (B)	0.313 in
Closure	Seal or Shield Available
Ring Material	52100 Chrome Steel
Ball Material	52100 Chrome Steel
Brand	KAYDON
L1	4.699 in
L2	4.925 in

COMPONENT	Precision Thin Section
JB045CP0 KAYDON 4.5in X 5.125in X .313in, Thin Section Bearing, Radial Contact Type-c, Sealed Reali-slim, Also Avail. In Stainless Steel	UNIT
	INCH
	SHEET



Pacific International Bearing, Inc.
 33258 Central Ave, Union City, CA 94587
 1-800-228-8895, 510-512-7000,
 info@pibsales.com
 www.pibsales.com

This file and any associated information and specifications are provided for reference and evaluation purposes only, and is subject to change without notice. PIB makes no representations, warranties or guarantees as to the appropriateness, accuracy, completeness, or suitability for any purpose, of the file, information or specifications. You are solely responsible for the use of the file, information or specifications.