

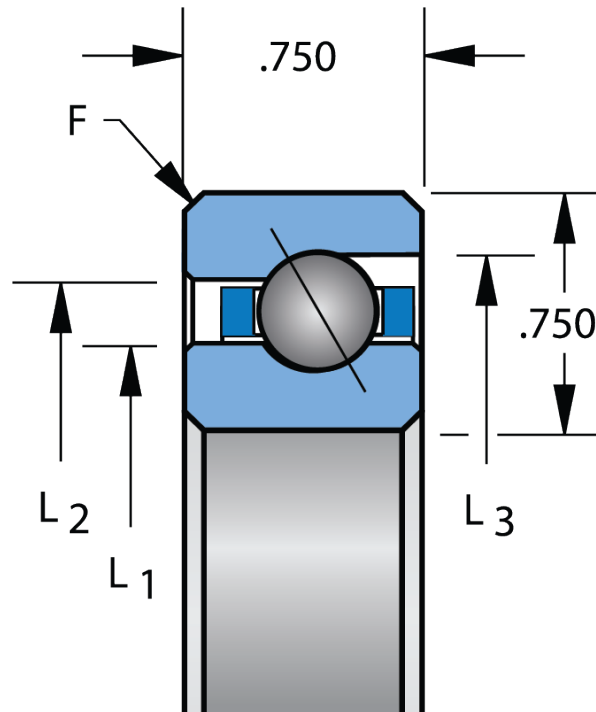

3/8" balls



$F = .080^4$

Bore Diameter (d)	4.4998 in
Outside Diameter (D)	6.0003 in
Width (B)	.7500 in
Closure	Open
Ring Material	Corrosion Resistant Plated
Ball Material	Corrosion Resistant Plated
Brand	KAYDON
L1	5.0600 in
L2	5.4450 in

COMPONENT	Thin Section
-----------	--------------



Pacific International Bearing, Inc.
 33258 Central Ave, Union City, CA 94587
 1-800-228-8895, 510-512-7000,
 info@pibsales.com
 www.pibsales.com

This file and any associated information and specifications are provided for reference and evaluation purposes only, and is subject to change without notice. PIB makes no representations, warranties or guarantees as to the appropriateness, accuracy, completeness, or suitability for any purpose, of the file, information or specifications. You are solely responsible for the use of the file, information or specifications.

NF045AR0
KAYDON
 4.4998in X 6.0003in X .7500in, Thin Section
 Bearing, Angular Contact Type A,
 Endurakote Anti-corrosion, Open

UNIT
Inch
SHEET