

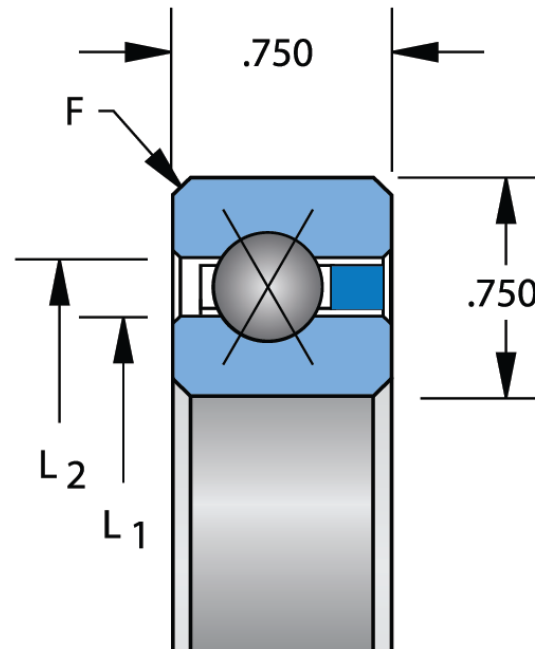

3/8" balls



$$F = .080^3$$

Bore Diameter (d)	7.9998 in
Outside Diameter (D)	9.5003 in
Width (B)	.7500 in
Closure	Corrosion Resistant Plated
Ring Material	Corrosion Resistant Plated
Brand	KAYDON
L1	8.5550 in
L2	8.9450 in

COMPONENT	Thin Section	UNIT
NF080XP0 KAYDON 7.9998in X 9.5003in X .7500in, Thin Section Bearings, Four Point Contact Type-x, Endurakote Anti-corrosion, Open		Inch
		SHEET



Pacific International Bearing, Inc.
 33258 Central Ave, Union City, CA 94587
 1-800-228-8895, 510-512-7000,
 info@pibsales.com
 www.pibsales.com

This file and any associated information and specifications are provided for reference and evaluation purposes only, and is subject to change without notice. PIB makes no representations, warranties or guarantees as to the appropriateness, accuracy, completeness, or suitability for any purpose, of the file, information or specifications. You are solely responsible for the use of the file, information or specifications.