

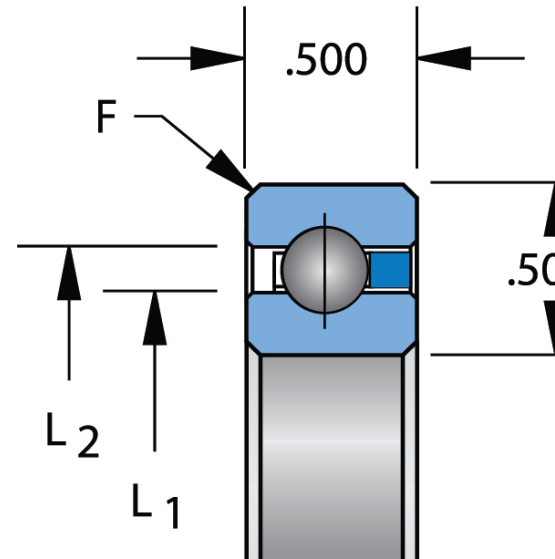

1/4" balls



$F = .060^4$

Bore Diameter (d)	16.0 in
Outside Diameter (D)	17.0 in
Width (B)	.5000 in
Closure	Open
Ring Material	Stainless Steel
Ball Material	Stainless Steel
Brand	KAYDON
L1	16.3700 in
L2	16.6300 in

COMPONENT	Thin Section
-----------	--------------



**Pacific International Bearing, Inc.**  
 33258 Central Ave, Union City, CA 94587  
 1-800-228-8895, 510-512-7000,  
 info@pibsales.com  
 www.pibsales.com

This file and any associated information and specifications are provided for reference and evaluation purposes only, and is subject to change without notice. PIB makes no representations, warranties or guarantees as to the appropriateness, accuracy, completeness, or suitability for any purpose, of the file, information or specifications. You are solely responsible for the use of the file, information or specifications.

**SD160CP0**  
**KAYDON**  
 16in X 17in X .5000in, Thin Section Bearing,  
 Radial Contact Type-c, Open Reali-slim,  
 Stainless Steel

UNIT
Inch
SHEET