

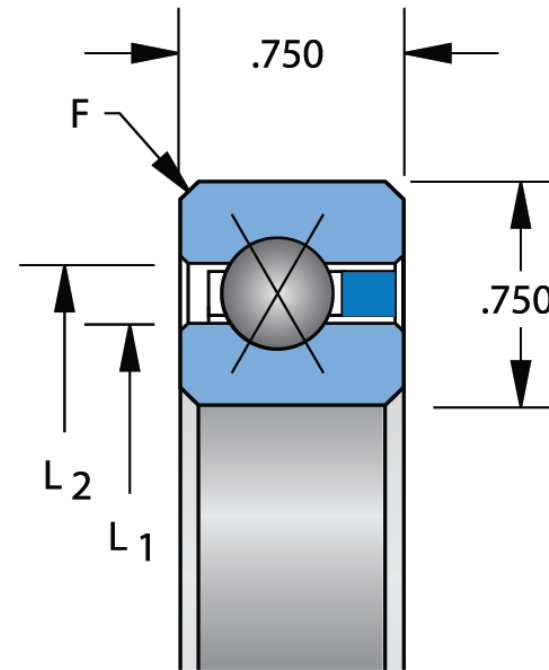

3/8" balls



$$F = .080^3$$

Bore Diameter (d)	4.0 in
Outside Diameter (D)	5.5000 in
Width (B)	.7500 in
Closure	Open
Ring Material	Stainless Steel
Ball Material	Stainless Steel
Brand	KAYDON
L1	4.5550 in
L2	4.9450 in

COMPONENT	Thin Section
-----------	--------------



Pacific International Bearing, Inc.
 33258 Central Ave, Union City, CA 94587
 1-800-228-8895, 510-512-7000,
 info@pibsales.com
 www.pibsales.com

This file and any associated information and specifications are provided for reference and evaluation purposes only, and is subject to change without notice. PIB makes no representations, warranties or guarantees as to the appropriateness, accuracy, completeness, or suitability for any purpose, of the file, information or specifications. You are solely responsible for the use of the file, information or specifications.

SF040XP0 KAYDON 4in X 5.5000in X .7500in, Thin Section Bearing, Four Point Contact Type-x, Open Reali-slim, Stainless Steel	UNIT
	Inch
	SHEET